



Design Guide

HEH/HEV Series

Table of Contents

HE Series

Unit Features	4
Intelligent Communicating Controls	5
Internal Variable Water Flow Control	6
Selection Procedure	7
HE Series Nomenclature	9
Performance Data AHRI/ASHRAE/ISO 13256-1	10
Performance Data – HE H/V 024 (Part Load) with Modulating Valve or Variable Speed Pump	11
Performance Data – HE H/V 024 (Full Load) with Modulating Valve or Variable Speed Pump	12
Performance Data – HE H/V 030 (Part Load) with Modulating Valve or Variable Speed Pump	13
Performance Data – HE H/V 030 (Full Load) with Modulating Valve or Variable Speed Pump	14
Performance Data – HE H/V 036 (Part Load) with Modulating Valve or Variable Speed Pump	15
Performance Data – HE H/V 036 (Full Load) with Modulating Valve or Variable Speed Pump	16
Performance Data – HE H/V 042 (Part Load) with Modulating Valve or Variable Speed Pump	17
Performance Data – HE H/V 042 (Full Load) with Modulating Valve or Variable Speed Pump	18
Performance Data – HE H/V 048 (Part Load) with Modulating Valve or Variable Speed Pump	19
Performance Data – HE H/V 048 (Full Load) with Modulating Valve or Variable Speed Pump	20
Performance Data – HE H/V 060 (Part Load) with Modulating Valve or Variable Speed Pump	21
Performance Data – HE H/V 060 (Full Load) with Modulating Valve or Variable Speed Pump	22
Part Load Performance Data – Correction Tables	23
Full Load Performance Data – Correction Tables	24
High Head Variable Pump Performance	25
Antifreeze & Water Pressure Drop Adder for Options – Correction Tables	26
ECM Blower Control	29
Blower Performance Data	30
Physical Data	31
HE - Horizontal Dimensional Data	32
HE - Vertical Upflow Dimensional Data	34
Corner Weights	36
Electrical Data	37
HE Series Wiring Diagram Matrix	39
Engineering Specifications	49
Performance Sheet	57
Revision History	58

THE HE TWO-STAGE SERIES

The HE Series includes the superb efficiency ratings, quiet operation, and application flexibility that is synonymous with the Comfort-Aire/Century family. HE units are available in capacities of 24, 30, 36, 42, 48, and 60 Mbtuh in vertical upflow and horizontal configurations. Other features include the next generation Copeland UltraTech™ two-stage scroll compressor, variable speed ECM fan motor, and digital communicating controls. It also has one of the industry's smallest footprints, making it suitable for installation in tight places and retrofit projects.

Available in sizes 2 tons (7.0 kW) through 5 tons (17.6 kW) with multiple cabinet options (vertical upflow and horizontal) the HE Series offers a wide range of units for most any installation. The HE Series has an extended range refrigerant circuit, capable of ground loop (geothermal) applications as well as water loop (boiler-tower) applications. Some of the features of the innovative HE Series include: Copeland UltraTech two-stage unloading scroll compressor, ECM variable fan motor, microprocessor controls, galvanized steel cabinet, stainless steel drain pan, and acoustic type fiber insulation.

Comfort-Aire/Century's exclusive double isolation compressor mounting system makes the HE Series one of the quietest units on the market. Compressors are mounted on specially engineered sound tested EPDM grommets to a heavy gauge mounting plate, which is then isolated from the cabinet base with rubber grommets for maximized vibration/sound attenuation. Multiple removable access panels and an easily accessible control box make installation and maintenance user friendly. Options such as coated air coil, DDC controls, internal variable speed pumps, modulating water valves, and high efficiency MERV rated air filters allow for customizable design solutions.

Intelligent communicating technology is the next generation in intelligent control that uses two-way communication to provide a gateway into the system. The intelligent control system allows end-users and contractors to monitor the performance of the unit, custom tailor its operation, and diagnose any issues, right from the thermostat.

The intelligent communications hub is the new DXM2 intelligent controller, which analyzes the status of sensors and smart components (which are also two-way communicating) to determine how best to operate the system for optimal comfort, efficiency and long-term reliability. All of this information is passed to the communicating thermostat (or configuration/diagnostic tool), where it can be displayed in plain English. And since communication is both ways, the communicating thermostat can also be used to configure and tailor the system without even touching the unit.

Variable water flow technology represents a major advancement in geothermal system performance - made possible through the intelligent communicating system. Variable flow not only builds the major water circulation components into the unit for a clean installation, it also intelligently varies the water flow to minimize pump energy consumption and improve system reliability.

The heart of the variable flow feature is either a variable-speed pump or modulating water valve directly linked to the intelligent communicating system. Water flow is automatically varied based on changes in unit capacity level (stage) and source water temperature to maintain optimum system performance. Variable flow allows the use of direct return piping, while eliminating external two-way valves and automatic flow regulators - making variable flow systems inherently self-balancing.

Variable flow systems provide reduced water pumping power compared to traditional fixed-speed pumping systems. They also protect the unit against extreme operating conditions, thus extending the life of the compressor and air coil. Since variable flow is built inside the unit, it also saves on installation time and makes for a very clean and compact installation. The HE Series water-source heat pumps are designed to meet the challenges of today's HVAC demands with one of the most innovative products available on the market.

UNIT FEATURES

- Sizes 024 (2 ton, 7.0 kW) through 060 (5 tons, 17.6 kW)
- EarthPure® (HFC-410A) refrigerant
- Copeland UltraTech™ two-stage unloading scroll compressors
- ECM variable speed fan motor with soft start
- DXM2 two-way communicating controller
- Exceeds ASHRAE 90.1 efficiencies
- Part load operation significantly lowers annual operating costs
- Galvanized steel construction
- Cabinet lined with acoustic type fiber insulation
- Unique double isolation compressor mounting with vibration isolation for quiet operation
- Insulated divider and separate compressor/air handler compartments
- TXV metering device
- Available extended range (20° to 120°F, -6.7° to 48.9°C) operation
- Advanced Controls - intelligent communicating control provides advanced unit functionality and comprehensive configuration, monitoring and diagnostic capabilities through digital communication links with the variable-speed fan motor, variable-speed source pump (or modulating valve) and communicating thermostat or configuration/diagnostic tool.
- 7 temperature sensor inputs for system protection and control
- Anti-short cycle and over/under voltage protection
- High pressure, loss of charge, and condensate overflow protection
- LED fault and status indication at controller
- Service tool port for optional setup and diagnostics at unit
- BACnet, Modbus and Johnson N2 compatibility options for DDC controls
- Field convertible discharge air arrangement for horizontal units
- Easy access control box
- Flush securely-mounted corner post water connections and electrical service disconnects.
(no backup wrench required)
- Unit Performance Sentinel performance monitoring system
- Eight Safeties Standard
- Wide variety of options including ultra quiet sound insulation, extended range insulation, return air filter frames, variable and fixed speed circulating pumps, modulating motorized valves, hot water generator, and cupro-nickel water coil
- Stainless steel drain pan

Intelligent Communicating Controls

Information gateway to monitor, control, and diagnose your system

The HE is equipped with industry-first – Information Gateway – 2-way communicating system. Intelligent communication allows users to interact with their geothermal system in plain English. It delivers improved reliability and efficiency by precisely controlling smart variable speed components. Intelligent communication makes the HE Series the easiest products to install and service.

Monitor/Configure – Installers can configure HE units from the thermostat. This includes: Air flow, loop delta T, water-flow option configuration, unit configuration, accessory configuration, and demand reduction (optional - to limit unit operation during peak times). Users can look up the current system status: temperature sensor readings and operational status of the blower and pump.

Precise Control – The DXM2 board enables intelligent, 2-way communication between the DXM2 board and smart components like the communicating thermostat, fan motor, and water pump. The DXM2 board can also directly control the modulating valve and accepts various feedback/input. The Intelligent DXM2 board uses information received from the smart components/sensors to precisely control operation of variable speed fan, variable speed water pump (or modulating valve) to deliver higher efficiency, reliability and increased comfort.

Diagnostics – Intelligent communicating controls takes diagnosing geothermal units to the next level of simplicity, by providing a dashboard of system and fault information, in plain English, on the communicating thermostat/ service tool.

The Service Warning feature will alert the occupant of a fault and display dealer information (if programmed), fault description, possible causes, current system status (temperature readings, fan RPM, and water flow status) which may be reported to service personnel.

In Service Mode, the service personnel can access fault description, possible causes, and most importantly, the conditions (temp, flow, i/o conditions, configuration) at the time of the fault and at the time of the call. Manual Operation mode allows the service personnel to manually command operation for any of the thermostat outputs, blower speed, pump speed, or valve position from the thermostat to help troubleshoot specific components.

With the intelligent communicating system, consumers and contractors have a gateway to system information never before available.

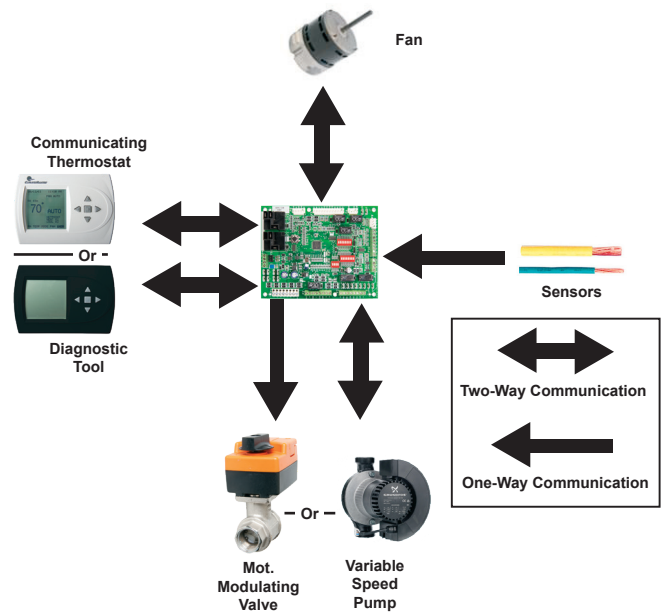

AIRFLOW SELECTION	
HEAT STAGE 1	600 CFM
HEAT STAGE 2	750
AUXILIARY HEAT	850
EMERGENCY HEAT	850
COOL STAGE 1	525
COOL STAGE 2	700
COOL DEHUMID 1	425
COOL DEHUMID 2	550
CONTINUOUS FAN	350
HEAT OFF DELAY	60
COOL OFF DELAY	30
◀ PREVIOUS	NEXT ▶

POSSIBLE FAULT CAUSES	
LOW WATER COIL TEMP	
LOW WATER TEMP - HTG	
LOW WATER FLOW - HTG	
LOW REFRIG CHARGE - HTG	
INCORRECT LT1 SETTING	
BAD LT1 THERMISTOR	
◀ PREVIOUS	

FAULT TEMPERATURE CONDITIONS	
LT1 LOW WATER TEMP	
HEAT 1 11:11 AM 11/14	
LT1 TEMP	28.1
LT2 TEMP	97.3
HOT WATER EWT	121.5
COMP DISCHARGE	157.7
LEAVING AIR	92.7
LEAVING WATER	34.9
ENTERING WATER	42.1
CONTROL VOLTAGE	26.4
◀ PREVIOUS	

Internal Variable Water Flow Control

Internal Variable Water Flow

Industry-first, Built-in variable water flow replaces a traditionally inefficient, external component of the system (water circulation) with an ultra-high-efficient, variable speed, internal water flow system. This saves 70-80% on operating water circulator vs traditional single speed pump systems. It saves installers time and labor by avoiding installing bulky external pumps or flow regulators. Multi-unit installations are also much simpler with variable flow systems, as the units automatically adjust water flow across the system.

The variable flow system is enabled by intelligent communicating controls, which facilitates intelligent communication between the thermostat, DXM2 control, sensors, and internal water pump/valve to make true variable water flow a reality.

Variable flow is available in four variations:

1. Low System Pressure Drop Modulating Valve – High CV motorized valve for central pumping. (Standard Unit).
2. High System Pressure Drop Modulating Valve – Motorized valve for higher pressure water system such as water well pumps. (Optional).
3. Standard Head Variable Pump – multi unit/central pumping. (Optional).
4. High Head Variable Pump – multi/individual unit pumping. (Optional).

Variable flow delivers three main benefits:

1. Easier and quicker unit installation as the flow control is built in to the unit.
2. Superior reliability by varying the water flow to deliver more stable operation.
3. Increased cost savings by varying the flow (and pump watt consumption) to match the unit's mode of operation.

Internal components

The HE Series can be installed more easily and compactly than its predecessors because water-flow components are internal to the unit. It also saves installing contractors labor and time by eliminating the need for an external flow regulator or a bulky external pumping module.

Variable flow

Variable flow technology enables variable water flow through the unit, with the DXM2 control adjusting the pump speed to maintain an installer-set loop delta T. By controlling the water flow, the system is able to operate at its optimal capacity and efficiency. Variable flow provides a lower flow rate for part load where units typically operate 80% of the time and a higher, more normal flow rate for full load operation.

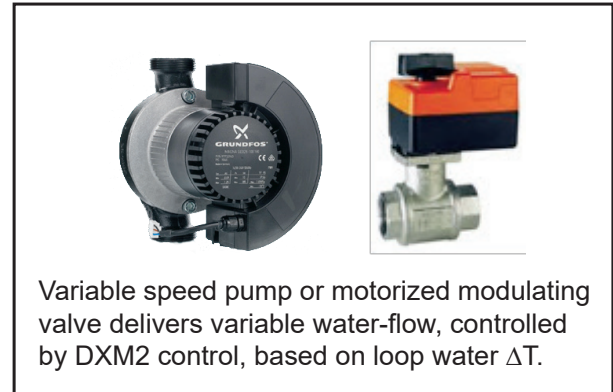

Energy Savings with water circulation control

Units with variable flow deliver greater operating cost savings by varying the water flow to match the unit's operation (ex: lower water flow when unit is in part load operation). Lowering the flow results in lower energy consumption by the water pump (=greater cost savings) in variable flow units (whether internal or external pump).

In applications using variable flow with internal variable speed (ECM) pump, the ECM pump uses fewer watts than a fixed speed (PSC) pump, even at full load. The ECM pump excels in energy savings in part load, saving 70-80% watts compared to fixed speed pumps (see chart). The ECM pump can operate with independent flow rates for both heating and cooling operations allowing for more energy savings.

In loop applications, when the motorized modulating valve slows down the water flow during part load operation, the external pump consumes fewer watts, thus saving more energy.

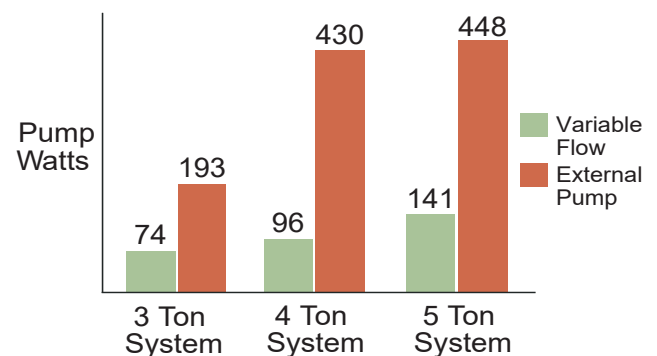

Reference Calculations

Heating	Cooling	
$LWT = EWT - \frac{HE}{GPM \times \text{Constant}}$	$LWT = EWT + \frac{HR}{GPM \times \text{Constant}}$	$LC = TC - SC$
$LAT = EAT + \frac{HC}{CFM \times 1.08}$	$LAT (DB) = EAT (DB) - \frac{SC}{CFM \times 1.08}$	$S/T = \frac{SC}{TC}$

Constant = 500 for water, 485 for antifreeze.

Legend and Glossary of Abbreviations

BTUH = BTU (British Thermal Unit) per hour	GPM = water flow in U.S. gallons/minute
MBTUH = 1,000 BTU per hour	WPD = waterside pressure drop (psi & ft. of hd.)
TC = total cooling capacity, BTUH	HE = total heat of extraction, BTUH
SC = sensible cooling capacity, BTUH	HR = total heat of rejection, BTUH
S/T = sensible to total cooling ratio	KW = total power unit input, kilowatts
LC = latent cooling capacity, BTUH	EER = energy efficient ratio = BTUH output/Watt input
HC = air heating capacity, BTUH	COP = coefficient of performance = BTUH output/BTUH input
CFM = airflow, cubic feet/minute	MPT = male pipe thread
ESP = external static pressure (inches w.g.)	FPT = female pipe thread
EAT = entering air temperature	HWC = hot water generator (desuperheater) capacity, Mbtuh
LAT = leaving air temperature, °F	ECM-CV = electronic commutated constant volume fan motor
DB = dry bulb temperature (°F)	ECM-CT = electronic commutated constant torque fan motor
WB = wet bulb temperature (°F)	MWV = motorized water valve
EWT = entering water temperature	WSE = waterside economizer
LWT = leaving water temperature, °F	VFD = variable frequency drive
TD or delta T = temperature differential	

Conversion Table - to convert inch-pound (English) to S-I (Metric)

Air Flow	Water Flow	Est Static Pressure	Water Pressure Drop
Airflow (L/s) = CFM x 0.472	Water Flow (L/s) = gpm x 0.0631	ESP (Pa) = ESP (in of wg) x 249	PD (kPa) = PD (ft of hd) x 2.99

Selection Procedure

- Step 1** Determine the actual heating and cooling loads at the desired dry bulb and wet bulb conditions.
- Step 2** Obtain the following design parameters: Entering water temperature, water flow rate in GPM, air flow in CFM, water flow pressure drop and design wet and dry bulb temperatures. Air flow CFM should be between 300 and 450 CFM per ton. Unit water pressure drop should be kept as close as possible to each other to make water balancing easier. Go to the appropriate tables and find the proper indicated water flow and water temperature.
- Step 3** Select a unit based on total and sensible cooling conditions. Select a unit which is closest to, but no larger than, the actual cooling load.
- Step 4** Enter tables at the design water flow and water temperature. Read the total and sensible cooling capacities (Note: interpolation is permissible, extrapolation is not).
- Step 5** Read the heating capacity. If it exceeds the design criteria it is acceptable. It is quite normal for Water-Source Heat Pumps to be selected on cooling capacity only since the heating output is usually greater than the cooling capacity.
- Step 6** Determine the correction factors associated with the variable factors of dry bulb and wet bulb.
- Corrected Total Cooling =
tabulated total cooling x wet bulb correction.
- Corrected Sensible Cooling =
tabulated sensible cooling x wet/dry bulb correction.
- Step 7** Compare the corrected capacities to the load requirements. Normally if the capacities are within 10% of the loads, the equipment is acceptable. It is better to undersize than oversize, as undersizing improves humidity control, reduces sound levels and extends the life of the equipment.
- Step 8** When completed, calculate water temperature rise and assess the selection. If the units selected are not within 10% of the load calculations, then review what effect changing the GPM, water temperature and/or air flow and air temperature would have on the corrected capacities. If the desired capacity cannot be achieved, select the next larger or smaller unit and repeat the procedure. Remember, when in doubt, undersize slightly for best performance.

Example Equipment Selection For Cooling Step 1 Load Determination:

Assume we have determined that the appropriate cooling load at the desired dry bulb 80°F and wet bulb 65°F conditions is as follows:

Total Cooling22,000 BTUH
Sensible Cooling.....18,200 BTUH
Entering Air Temp.....80°F Dry Bulb / 65°F Wet Bulb

Step 2 Design Conditions:

Similarly, we have also obtained the following design parameters:

Entering Water Temp.....90°F
Water Flow (Based upon 10°F rise in temp.)4.5 GPM
Air Flow.....600 CFM

Steps 3, 4, & 5 HP Selection:

After making our preliminary selection (HEH024 - Full Load), we enter the tables at design water flow and water temperature and read Total Cooling, Sens. Cooling and Heat of Rej. capacities:

Total Cooling.....22,500 BTUH
Sensible Cooling.....16,500 BTUH
Heat of Rejection.....28,800 BTUH

Steps 6 & 7 Entering Air and Airflow Corrections:

Next, we determine our correction factors.

Table Ent Air Air Flow Corrected

Corrected Total Cooling = $22,500 \times 0.976 \times 0.967 = 21,235$
Corrected Sens Cooling = $16,500 \times 0.919 \times 1.089 = 16,513$
Corrected Heat of Reject = $28,800 \times 0.969 \times 0.972 = 27,126$

Step 8 Water Temperature Rise Calculation and Assessment:

Actual Temperature Rise.....12.1°F

When we compare the Corrected Total Cooling and Corrected Sensible Cooling figures with our load requirements stated in Step 1, we discover that our selection is within +/- 10% of our sensible load requirement. Furthermore, we see that our Corrected Total Cooling figure is within 1,000 Btuh of the actual indicated load.

HE Series Nomenclature

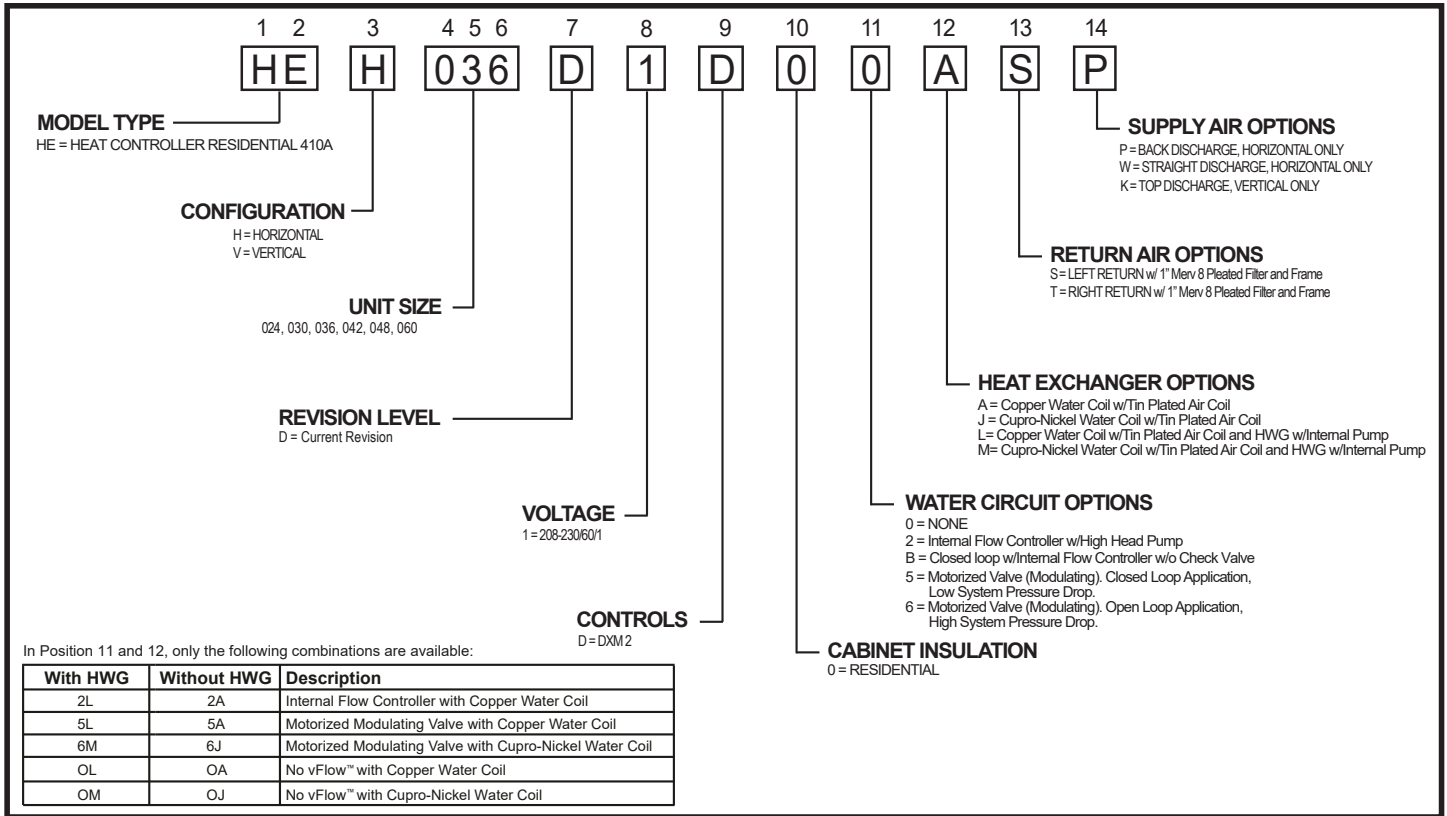

Performance Data – AHRI/ASHRAE/ISO 13256-1

ASHRAE/AHRI/ISO 13256-1. English (I-P) Units

Model	Water Loop Heat Pump				Ground Water Heat Pump				Ground Loop Heat Pump			
	Cooling 86°F		Heating 68°F		Cooling 59°F		Heating 50°F		Full Cool 77°F Part Cool 68°F		Full Heat 32°F Part Heat 41°F	
	Capacity Btuh	EER Btuh/W	Capacity Btuh	COP	Capacity Btuh	EER Btuh/W	Capacity Btuh	COP	Capacity Btuh	EER Btuh/W	Capacity Btuh	COP
HE*024 Part	18,100	16.1	20,600	5.2	20,300	27.2	16,700	4.4	19,400	22.2	14,700	4.0
HE*024 Full	23,700	14.3	28,000	4.6	26,500	21.7	23,000	4.1	24,600	16.0	17,800	3.6
HE*030 Part	21,900	15.2	26,300	5.0	24,900	24.8	22,000	4.3	24,200	20.9	19,400	3.9
HE*030 Full	28,500	14.0	35,800	4.6	32,300	20.7	30,000	4.2	29,900	15.7	23,800	3.6
HE*036 Part	25,800	17.2	29,900	5.3	29,000	29.4	24,900	4.6	27,300	23.4	21,500	4.0
HE*036 Full	34,300	15.1	42,000	4.6	38,200	22.3	35,100	4.3	35,200	16.7	27,300	3.6
HE*042 Part	31,000	15.8	36,800	5.1	35,200	26.4	30,500	4.3	34,000	22.0	26,900	3.8
HE*042 Full	41,100	14.3	50,200	4.6	46,300	21.3	42,300	4.1	43,100	16.1	33,300	3.4
HE*048 Part	34,100	15.2	39,500	5.5	39,200	26.8	32,600	4.6	37,600	21.2	29,200	4.1
HE*048 Full	45,900	14.0	53,800	4.9	51,800	20.9	45,000	4.4	48,100	15.5	35,600	3.7
HE*060 Part	45,500	17.7	49,000	5.3	50,400	28.9	39,800	4.5	48,600	23.7	34,800	4.0
HE*060 Full	61,700	15.7	67,500	4.8	68,000	22.7	55,400	4.3	63,200	17.3	43,700	3.6

Cooling capacities based upon 80.6°F DB, 66.2°F WB entering air temperature

Heating capacities based upon 68°F DB, 59°F WB entering air temperature

Ground Loop Heat Pump ratings based on 15% antifreeze solution

All ratings based upon operation at lower voltage of dual voltage rated models

ASHRAE/AHRI/ISO 13256-1. English (I-P) Units

Model	Water Loop Heat Pump				Ground Water Heat Pump				Ground Loop Heat Pump			
	Cooling 30°C		Heating 20°C		Cooling 15°C		Heating 10°C		Full Cool 25°C Part Cool 20°C		Full Heat 0°C Part Heat 5°C	
	Capacity kW	EER Btuh/W	Capacity kW	COP	Capacity kW	EER Btuh/W	Capacity kW	COP	Capacity kW	EER Btuh/W	Capacity kW	COP
HE*024 Part	5.30	4.7	6.04	5.2	5.95	8.0	4.89	4.4	5.68	6.5	4.31	4.0
HE*024 Full	6.94	4.2	8.20	4.6	7.76	6.4	6.74	4.1	7.21	4.7	5.22	3.6
HE*030 Part	6.42	4.5	7.71	5.0	7.30	7.3	6.45	4.3	7.09	6.1	5.69	3.9
HE*030 Full	8.35	4.1	10.49	4.6	9.47	6.1	8.79	4.2	8.76	4.6	6.98	3.6
HE*036 Part	7.56	5.0	8.76	5.3	8.50	8.6	7.30	4.6	8.00	6.9	6.30	4.0
HE*036 Full	10.05	4.4	12.31	4.6	11.19	6.5	10.28	4.3	10.31	4.9	8.00	3.6
HE*042 Part	9.09	4.6	10.79	5.1	10.32	7.7	8.94	4.3	9.96	6.4	7.88	3.8
HE*042 Full	12.05	4.2	14.71	4.6	13.57	6.2	12.40	4.1	12.63	4.7	9.76	3.4
HE*048 Part	9.99	4.5	11.58	5.5	11.49	7.9	9.55	4.6	11.02	6.2	8.56	4.1
HE*048 Full	13.45	4.1	15.77	4.9	15.18	6.1	13.19	4.4	14.10	4.5	10.43	3.7
HE*060 Part	13.3	5.2	14.36	5.3	14.77	8.5	11.66	4.5	14.24	6.9	10.20	4.0
HE*060 Full	18.1	4.6	19.78	4.8	19.93	6.7	16.24	4.3	18.52	5.1	12.80	3.6

Cooling capacities based upon 27°C DB, 19°C WB entering air temperature

Heating capacities based upon 20°C DB, 15°C WB entering air temperature

Ground Loop Heat Pump ratings based on 15% antifreeze solution

All ratings based upon operation at lower voltage of dual voltage rated models

Performance Data – HE H/V 024 (Part Load) with Modulating Valve or Variable Speed Pump

600 CFM Nominal (Rated) Airflow Cooling, 600 CFM Nominal (Rated) Airflow Heating

Performance capacities shown in thousands of Btuh

EWT °F	GPM	WPD		COOLING - EAT 80/67°F							GPM	WPD			HEATING - EAT 70°F						
		PSI	FT	TC	SC	kW	HR	EER	LWT	HWC Cap		PSI	FT	HC	kW	HE	COP	LAT	LWT	HWC Cap	
20	1.2	0.3	0.7	22.4	15.2	0.71	24.9	31.6	60.0	0.9	4.5	3.1	7.2	10.8	1.12	7.0	2.8	84.6	16.9	1.9	
	1.7	0.3	0.6	22.4	15.2	0.71	24.9	31.6	60.0	0.9	2.3	0.6	1.5	12.3	1.14	8.4	3.2	86.9	22.6	1.9	
	1.7	0.3	0.6	22.4	15.2	0.71	24.9	31.6	60.0	0.9	3.4	1.5	3.4	12.9	1.15	9.0	3.3	87.8	24.7	1.9	
30	1.7	0.3	0.6	22.4	15.2	0.71	24.9	31.6	60.0	0.9	4.5	2.4	5.6	13.2	1.15	9.3	3.4	88.3	25.9	2.0	
	2.5	0.5	1.2	22.4	15.2	0.71	24.9	31.6	60.0	0.9	2.3	0.4	0.8	14.5	1.16	10.6	3.7	90.4	30.6	2.0	
	2.5	0.5	1.2	22.4	15.2	0.71	24.9	31.6	60.0	0.9	3.4	1.1	2.5	15.3	1.17	11.3	3.8	91.6	33.3	2.1	
40	2.5	0.5	1.2	22.4	15.2	0.71	24.9	31.6	60.0	0.9	4.5	1.9	4.5	15.8	1.18	11.7	3.9	92.3	34.8	2.1	
	2.3	0.2	0.5	21.5	14.7	0.82	24.3	26.2	71.6	1.2	2.3	0.2	0.5	16.9	1.19	12.8	4.2	94.0	38.6	2.1	
	3.4	0.8	2.0	22.1	15.0	0.75	24.7	29.5	64.5	1.0	3.4	0.8	2.0	17.8	1.20	13.7	4.4	95.5	41.9	2.2	
50	4.5	1.6	3.7	22.4	15.2	0.72	24.8	31.0	61.0	0.9	4.5	1.6	3.7	18.4	1.21	14.2	4.5	96.3	43.7	2.2	
	2.3	0.1	0.3	20.7	14.3	0.94	23.9	21.9	81.2	1.7	2.3	0.1	0.3	19.2	1.22	15.0	4.6	97.5	46.6	2.3	
	3.4	0.7	1.6	21.3	14.6	0.85	24.2	25.0	74.2	1.3	3.4	0.7	1.6	20.2	1.23	16.0	4.8	99.2	50.6	2.4	
60	4.5	1.4	3.2	21.6	14.8	0.81	24.4	26.5	70.8	1.2	4.5	1.4	3.2	20.8	1.24	16.6	4.9	100.0	52.6	2.5	
	2.3	0.1	0.3	19.6	13.8	1.09	23.4	18.0	90.8	2.3	2.3	0.1	0.3	21.3	1.25	17.1	5.0	100.8	54.8	2.5	
	3.4	0.7	1.5	20.4	14.1	0.98	23.7	20.7	84.0	1.8	3.4	0.7	1.5	22.4	1.26	18.1	5.2	102.4	59.4	2.6	
70	4.5	1.2	2.9	20.7	14.3	0.94	23.9	22.1	80.6	1.6	4.5	1.2	2.9	22.9	1.27	18.5	5.3	103.2	61.8	2.7	
	2.3	0.2	0.4	18.5	13.3	1.26	22.8	14.6	100.3	3.2	2.3	0.2	0.4	23.2	1.27	18.8	5.3	103.7	63.3	2.8	
	3.4	0.6	1.5	19.3	13.6	1.14	23.2	16.9	93.6	2.6	3.4	0.6	1.5	24.0	1.29	19.6	5.4	105.0	68.5	2.9	
80	4.5	1.2	2.7	19.7	13.8	1.08	23.4	18.1	90.4	2.3	4.0	0.9	2.1	24.3	1.30	19.8	5.5	105.4	70.0	3.0	
	2.3	0.2	0.5	17.2	12.8	1.46	22.2	11.7	109.7	4.2	2.0	0.2	0.5	24.3	1.30	19.8	5.5	105.4	70.0	3.0	
	3.4	0.7	1.5	18.1	13.1	1.33	22.6	13.6	103.3	3.5	2.0	0.2	0.5	24.3	1.30	19.8	5.5	105.4	70.0	3.0	
90	4.5	1.2	2.7	18.5	13.3	1.26	22.8	14.6	100.1	3.2	2.0	0.2	0.5	24.3	1.30	19.8	5.5	105.4	70.0	3.0	
	2.3	0.2	0.5	15.7	12.3	1.69	21.5	9.3	119.1	5.4	1.3	0.2	0.5	24.3	1.30	19.8	5.5	105.4	70.0	3.0	
	3.4	0.7	1.5	16.7	12.6	1.54	21.9	10.8	112.9	4.6	1.3	0.2	0.5	24.3	1.30	19.8	5.5	105.4	70.0	3.0	
100	4.5	1.1	2.7	17.1	12.8	1.47	22.1	11.7	109.8	4.2	1.3	0.2	0.5	24.3	1.30	19.8	5.5	105.4	70.0	3.0	
	2.3	0.2	0.4	14.1	11.8	1.94	20.7	7.3	128.4	6.8	1.0	0.1	0.2	24.3	1.30	19.8	5.5	105.4	70.0	3.0	
	3.4	0.6	1.4	15.1	12.1	1.78	21.2	8.5	122.5	5.9	1.0	0.1	0.2	24.3	1.30	19.8	5.5	105.4	70.0	3.0	
110	4.5	1.1	2.6	15.6	12.3	1.70	21.4	9.2	119.5	5.5	1.0	0.1	0.2	24.3	1.30	19.8	5.5	105.4	70.0	3.0	
	2.3	0.0	0.1	12.3	11.1	2.22	19.8	5.5	137.6	8.3	0.8	0.1	0.2	24.3	1.30	19.8	5.5	105.4	70.0	3.0	
	3.4	0.5	1.1	13.4	11.5	2.04	20.4	6.6	132.0	7.4	0.8	0.1	0.2	24.3	1.30	19.8	5.5	105.4	70.0	3.0	
120	4.5	1.0	2.3	13.9	11.7	1.96	20.6	7.1	129.2	6.9	0.8	0.1	0.2	24.3	1.30	19.8	5.5	105.4	70.0	3.0	

Interpolation is permissible; extrapolation is not.
 All entering air conditions are 80°F DB and 67°F WB in cooling, and 70°F DB in heating.
 AHRI/ISO certified conditions are 80.6°F DB and 66.2°F WB in cooling and 68°F DB in heating.
 Table does not reflect fan or pump power corrections for AHRI/ISO conditions.
 All performance is based upon the lower voltage of dual voltage rated units.
 Performance stated is at the rated power supply; performance may vary as the power supply varies from the rated.
 Operation below 40°F EWT is based upon a 15% methanol antifreeze solution.
 Operation below 60°F EWT requires optional insulated water/refrigerant circuit.
 See performance correction tables for operating conditions other than those listed above.
 See Performance Data Selection Notes for operation in the shaded areas.
 For unit operation in the shaded area when LWT is below 40°F (4.4°C) antifreeze must be used and the JW3 jumper on the DXM2 should be clipped. This is due to the potential of the refrigerant temperature being as low as 32°F (0°C) with 40°F (4.4°C) LWT, which may lead to a nuisance cutout due to the activation of the Low Temperature Protection. JW3 should never be clipped for standard range equipment or systems without antifreeze.
 Flow is controlled to maintain minimum LWT 60°F in cooling and maximum LWT 70°F in heating.

Performance Data – HE H/V 024 (Full Load) with Modulating Valve or Variable Speed Pump

750 CFM Nominal (Rated) Airflow Cooling, 750 CFM Nominal (Rated) Airflow Heating

Performance capacities shown in thousands of Btu/h

EWT °F	GPM	WPD		COOLING - EAT 80/67°F							GPM	WPD		HEATING - EAT 70°F						
		PSI	FT	TC	SC	kW	HR	EER	LWT	HWC Cap		PSI	FT	HC	kW	HE	COP	LAT	LWT	HWC Cap
20	1.7	0.7	1.5	29.3	19.2	1.18	33.3	24.9	60.0	1.3	6.0	4.8	11.1	15.7	1.49	10.6	3.1	87.3	16.5	2.3
	2.2	0.6	1.4	29.3	19.2	1.18	33.3	24.9	60.0	1.3	3.0	1.2	2.7	17.4	1.53	12.2	3.3	89.5	21.9	2.4
	2.2	0.6	1.4	29.3	19.2	1.18	33.3	24.9	60.0	1.3	4.5	2.4	5.6	18.2	1.56	12.9	3.4	90.5	24.3	2.5
30	2.2	0.6	1.4	29.3	19.2	1.18	33.3	24.9	60.0	1.3	6.0	3.9	9.1	18.7	1.57	13.3	3.5	91.0	25.6	2.5
	3.0	0.8	1.9	29.1	19.1	1.20	33.2	24.2	62.1	1.4	3.0	0.8	1.9	20.3	1.61	14.8	3.7	93.0	30.1	2.6
	3.3	1.0	2.4	29.3	19.2	1.18	33.3	24.9	60.0	1.3	4.5	1.9	4.5	21.4	1.63	15.8	3.8	94.4	33.0	2.7
40	3.3	1.0	2.4	29.3	19.2	1.18	33.3	24.9	60.0	1.3	6.0	3.3	7.6	22.0	1.65	16.4	3.9	95.1	34.5	2.8
	3.0	0.6	1.4	28.1	18.7	1.32	32.6	21.3	71.7	1.8	3.0	0.6	1.4	23.4	1.68	17.6	4.1	96.8	38.2	2.9
	4.5	1.6	3.7	28.8	19.0	1.23	33.0	23.4	64.7	1.5	4.5	1.6	3.7	24.6	1.71	18.8	4.2	98.3	41.6	3.0
50	6.0	2.8	6.5	29.2	19.1	1.19	33.2	24.5	61.1	1.3	6.0	2.8	6.5	25.3	1.73	19.4	4.3	99.2	43.5	3.1
	3.0	0.5	1.2	27.0	18.2	1.45	32.0	18.6	81.3	2.4	3.0	0.5	1.2	26.4	1.75	20.4	4.4	100.5	46.4	3.2
	4.5	1.4	3.2	27.8	18.5	1.35	32.4	20.5	74.4	2.0	4.5	1.4	3.2	27.7	1.79	21.6	4.5	102.2	50.4	3.4
60	6.0	2.5	5.7	28.2	18.7	1.31	32.6	21.5	70.9	1.8	6.0	2.5	5.7	28.5	1.81	22.3	4.6	103.1	52.6	3.4
	3.0	0.5	1.1	25.8	17.7	1.62	31.3	16.0	90.9	3.1	3.0	0.5	1.1	29.1	1.83	22.9	4.7	103.9	54.7	3.5
	4.5	1.2	2.9	26.7	18.0	1.50	31.8	17.8	84.1	2.6	4.5	1.2	2.9	30.5	1.88	24.1	4.8	105.5	59.3	3.7
70	6.0	2.2	5.2	27.1	18.2	1.44	32.0	18.8	80.7	2.4	6.0	2.2	5.2	31.1	1.90	24.6	4.8	106.3	61.8	3.8
	3.0	0.5	1.1	24.5	17.1	1.83	30.7	13.4	100.5	4.0	3.0	0.5	1.1	31.5	1.91	25.0	4.8	106.8	63.4	3.9
	4.5	1.2	2.7	25.4	17.5	1.68	31.2	15.2	93.8	3.4	4.5	1.2	2.7	32.5	1.97	25.8	4.8	108.1	68.5	4.2
80	6.0	2.1	4.9	25.9	17.7	1.61	31.4	16.1	90.5	3.1	5.2	1.6	3.7	32.8	1.98	26.0	4.8	108.3	70.0	4.2
	3.0	0.5	1.1	22.9	16.6	2.12	30.1	10.8	110.1	5.0	2.6	0.3	0.8	32.8	1.98	26.0	4.8	108.3	70.0	4.2
	4.5	1.2	2.7	24.0	17.0	1.92	30.5	12.5	103.6	4.3	2.6	0.3	0.8	32.8	1.98	26.0	4.8	108.3	70.0	4.2
90	6.0	2.0	4.7	24.5	17.2	1.83	30.8	13.4	100.3	3.9	2.6	0.3	0.8	32.8	1.98	26.0	4.8	108.3	70.0	4.2
	3.0	0.5	1.1	21.0	16.0	2.49	29.5	8.4	119.7	6.1	1.7	0.2	0.5	32.8	1.98	26.0	4.8	108.3	70.0	4.2
	4.5	1.2	2.7	22.3	16.4	2.23	29.9	10.0	113.3	5.3	1.7	0.2	0.5	32.8	1.98	26.0	4.8	108.3	70.0	4.2
100	6.0	2.0	4.6	22.9	16.6	2.12	30.1	10.8	110.0	5.0	1.7	0.2	0.5	32.8	1.98	26.0	4.8	108.3	70.0	4.2
	3.0	0.5	1.0	18.8	15.2	2.97	28.9	6.3	129.3	7.4	1.3	0.1	0.2	32.8	1.98	26.0	4.8	108.3	70.0	4.2
	4.5	1.1	2.6	20.3	15.7	2.65	29.3	7.7	123.0	6.5	1.3	0.1	0.2	32.8	1.98	26.0	4.8	108.3	70.0	4.2
110	6.0	1.9	4.4	21.0	16.0	2.50	29.5	8.4	119.8	6.1	1.3	0.1	0.2	32.8	1.98	26.0	4.8	108.3	70.0	4.2
	3.0	0.3	0.8	16.2	14.1	3.58	28.4	4.5	138.9	8.8	1.0	0.1	0.2	32.8	1.98	26.0	4.8	108.3	70.0	4.2
	4.5	1.0	2.3	17.9	14.9	3.17	28.7	5.6	132.8	7.9	1.0	0.1	0.2	32.8	1.98	26.0	4.8	108.3	70.0	4.2
120	6.0	1.8	4.2	18.7	15.2	2.99	28.9	6.3	129.6	7.4	1.0	0.1	0.2	32.8	1.98	26.0	4.8	108.3	70.0	4.2

Interpolation is permissible; extrapolation is not.

All entering air conditions are 80°F DB and 67°F WB in cooling, and 70°F DB in heating.

AHRI/ISO certified conditions are 80.6°F DB and 66.2°F WB in cooling and 68°F DB in heating.

Table does not reflect fan or pump power corrections for AHRI/ISO conditions.

All performance is based upon the lower voltage of dual voltage rated units.

Performance stated is at the rated power supply; performance may vary as the power supply varies from the rated.

Operation below 40°F EWT is based upon a 15% methanol antifreeze solution.

Operation below 60°F EWT requires optional insulated water/refrigerant circuit.

See performance correction tables for operating conditions other than those listed above.

See Performance Data Selection Notes for operation in the shaded areas.

For unit operation in the shaded area when LWT is below 40°F (4.4°C) antifreeze must be used and the JW3 jumper on the DXM2 should be clipped. This is due to the potential of the

refrigerant temperature being as low as 32°F (0°C) with 40°F (4.4°C) LWT, which may lead to a nuisance cutout due to the activation of the Low Temperature Protection. JW3 should never be clipped for standard range equipment or systems without antifreeze.

Flow is controlled to maintain minimum LWT 60°F in cooling and maximum LWT 70°F in heating.

Performance Data – HE H/V 030 (Part Load) with Modulating Valve or Variable Speed Pump

750 CFM Nominal (Rated) Airflow Cooling, 750 CFM Nominal (Rated) Airflow Heating

Performance capacities shown in thousands of Btuh

EWT °F	GPM	WPD		COOLING - EAT 80/67°F							GPM	WPD		HEATING - EAT 70°F							
		PSI	FT	TC	SC	KW	HR	EER	LWT	HWC Cap		PSI	FT	HC	KW	HE	COP	LAT	LWT	HWC Cap	
20	1.5	1.2	2.8	26.5	17.4	0.96	29.8	27.6	60.0	1.0	6.0	4.3	9.9	15.7	1.49	10.6	3.1	87.3	16.5	2.1	
	30	2.0	1.0	2.4	26.5	17.4	0.96	29.8	27.6	60.0	1.0	3.0	1.7	4.0	17.2	1.51	12.0	3.3	89.1	22.0	2.1
		2.0	1.0	2.4	26.5	17.4	0.96	29.8	27.6	60.0	1.0	4.5	2.7	6.3	17.8	1.52	12.6	3.4	89.9	24.4	2.2
40	2.0	1.0	2.4	26.5	17.4	0.96	29.8	27.6	60.0	1.0	6.0	3.8	8.9	18.2	1.52	13.0	3.5	90.4	25.7	2.2	
	40	3.0	1.2	2.8	26.5	17.4	0.96	29.8	27.6	60.0	1.0	3.0	1.3	3.0	19.5	1.55	14.2	3.7	92.0	30.5	2.3
		3.0	1.2	2.8	26.5	17.4	0.96	29.8	27.6	60.0	1.0	4.5	2.2	5.0	20.3	1.56	14.9	3.8	92.9	33.4	2.3
50	3.0	1.2	2.8	26.5	17.4	0.96	29.8	27.6	60.0	1.0	6.0	3.1	7.3	20.7	1.56	15.3	3.9	93.5	34.9	2.4	
	50	3.0	0.9	2.0	25.7	17.1	1.09	29.4	23.6	69.6	1.3	3.0	0.9	2.0	21.8	1.58	16.4	4.0	94.9	39.1	2.4
		4.5	1.6	3.6	26.3	17.3	1.00	29.7	26.3	63.2	1.1	4.5	1.6	3.6	22.7	1.60	17.3	4.2	96.0	42.3	2.5
60	6.0	2.4	5.6	26.5	17.4	0.96	29.8	27.6	60.0	1.0	6.0	2.4	5.6	23.2	1.61	17.7	4.2	96.6	44.1	2.6	
	60	3.0	0.8	1.9	24.6	16.6	1.23	28.8	19.9	79.2	1.8	3.0	0.8	1.9	24.2	1.62	18.6	4.4	97.8	47.6	2.6
		4.5	1.5	3.4	25.3	16.9	1.14	29.2	22.3	73.0	1.5	4.5	1.5	3.4	25.2	1.64	19.6	4.5	99.1	51.3	2.7
70	6.0	2.3	5.3	25.6	17.1	1.09	29.4	23.6	69.8	1.3	6.0	2.3	5.3	25.8	1.65	20.2	4.6	99.8	53.3	2.8	
	70	3.0	0.8	1.8	23.4	16.1	1.40	28.2	16.7	88.8	2.5	3.0	0.8	1.8	26.6	1.66	20.9	4.7	100.7	56.1	2.9
		4.5	1.4	3.2	24.2	16.4	1.29	28.6	18.7	82.7	2.0	4.5	1.4	3.2	27.7	1.68	22.0	4.8	102.2	60.2	3.0
80	6.0	2.2	5.0	24.5	16.6	1.24	28.8	19.8	79.6	1.8	6.0	2.2	5.0	28.4	1.69	22.6	4.9	102.9	62.5	3.0	
	80	3.0	0.8	1.8	22.1	15.5	1.59	27.5	13.9	98.3	3.3	3.0	0.8	1.8	29.0	1.70	23.2	5.0	103.7	64.6	3.1
		4.5	1.4	3.2	22.9	15.9	1.47	27.9	15.5	92.4	2.8	4.5	1.4	3.2	30.2	1.72	24.4	5.2	105.3	69.2	3.2
90	6.0	2.1	4.9	23.3	16.1	1.41	28.1	16.5	89.4	2.5	4.9	1.6	3.6	30.5	1.72	24.6	5.2	105.5	70.0	3.2	
	90	3.0	0.8	1.8	20.7	14.9	1.80	26.8	11.5	107.9	4.3	2.5	0.6	1.5	30.5	1.72	24.6	5.2	105.5	70.0	3.2
		4.5	1.4	3.2	21.5	15.3	1.67	27.2	12.9	102.1	3.7	2.5	0.6	1.5	30.5	1.72	24.6	5.2	105.5	70.0	3.2
100	6.0	2.1	4.8	21.9	15.5	1.61	27.4	13.6	99.1	3.4	2.5	0.6	1.5	30.5	1.72	24.6	5.2	105.5	70.0	3.2	
	100	3.0	0.7	1.7	19.3	14.3	2.03	26.3	9.5	117.5	5.5	1.6	0.4	0.9	30.5	1.72	24.6	5.2	105.5	70.0	3.2
		4.5	1.3	3.0	20.1	14.7	1.89	26.6	10.6	111.8	4.8	1.6	0.4	0.9	30.5	1.72	24.6	5.2	105.5	70.0	3.2
110	6.0	2.0	4.6	20.5	14.8	1.83	26.8	11.3	108.9	4.4	1.6	0.4	0.9	30.5	1.72	24.6	5.2	105.5	70.0	3.2	
	110	3.0	0.7	1.5	18.0	13.7	2.29	25.8	7.9	127.2	6.8	1.2	0.2	0.6	30.5	1.72	24.6	5.2	105.5	70.0	3.2
		4.5	1.2	2.8	18.8	14.0	2.14	26.1	8.8	121.6	6.0	1.2	0.2	0.6	30.5	1.72	24.6	5.2	105.5	70.0	3.2
120	6.0	1.9	4.4	19.2	14.2	2.06	26.2	9.3	118.7	5.6	1.2	0.2	0.6	30.5	1.72	24.6	5.2	105.5	70.0	3.2	
	120	3.0	0.6	1.4	Operation Not Recommended							1.0	0.1	0.2	30.5	1.72	24.6	5.2	105.5	70.0	3.2
		4.5	1.1	2.6	17.5	13.5	2.40	25.7	7.3	131.4	7.5	1.0	0.1	0.2	30.5	1.72	24.6	5.2	105.5	70.0	3.2
	6.0	1.8	4.1	17.9	13.6	2.32	25.8	7.7	128.6	7.0	1.0	0.1	0.2	30.5	1.72	24.6	5.2	105.5	70.0	3.2	

Interpolation is permissible; extrapolation is not.

All entering air conditions are 80°F DB and 67°F WB in cooling, and 70°F DB in heating.

AHRI/ISO certified conditions are 80.6°F DB and 66.2°F WB in cooling and 68°F DB in heating.

Table does not reflect fan or pump power corrections for AHRI/ISO conditions.

All performance is based upon the lower voltage of dual voltage rated units.

Performance stated is at the rated power supply; performance may vary as the power supply varies from the rated.

Operation below 40°F EWT is based upon a 15% methanol antifreeze solution.

Operation below 60°F EWT requires optional insulated water/refrigerant circuit.

See performance correction tables for operating conditions other than those listed above.

See Performance Data Selection Notes for operation in the shaded areas.

For unit operation in the shaded area when LWT is below 40°F (4.4°C) antifreeze must be used and the JW3 jumper on the DXM2 should be clipped. This is due to the potential of the refrigerant temperature being as low as 32°F (0°C) with 40°F (4.4°C) LWT, which may lead to a nuisance cutout due to the activation of the Low Temperature Protection. JW3 should never be clipped for standard range equipment or systems without antifreeze.

Flow is controlled to maintain minimum LWT 60°F in cooling and maximum LWT 70°F in heating.

Performance Data – HE H/V 030 (Full Load) with Modulating Valve or Variable Speed Pump

900 CFM Nominal (Rated) Airflow Cooling, 900 CFM Nominal (Rated) Airflow Heating

Performance capacities shown in thousands of Btu/h

EWT °F	GPM	WPD		COOLING - EAT 80/67°F							GPM	WPD		HEATING - EAT 70°F						
		PSI	FT	TC	SC	kW	HR	EER	LWT	HWC Cap		PSI	FT	HC	kW	HE	COP	LAT	LWT	HWC Cap
20	2.0	1.5	3.4	34.7	21.5	1.51	39.8	23.0	60.0	1.7	7.5	5.7	13.3	21.8	1.93	15.2	3.3	90.3	16.0	2.7
	2.7	1.4	3.2	34.7	21.5	1.51	39.8	23.0	60.0	1.7	3.8	2.3	5.2	23.5	1.99	16.7	3.5	92.1	21.1	2.8
	2.7	1.4	3.2	34.7	21.5	1.51	39.8	23.0	60.0	1.7	5.6	3.5	8.1	24.5	2.02	17.6	3.6	93.1	23.7	2.9
30	2.7	1.4	3.2	34.7	21.5	1.51	39.8	23.0	60.0	1.7	7.5	5.1	11.8	25.0	2.03	18.0	3.6	93.6	25.2	2.9
	3.8	1.7	4.0	34.5	21.5	1.53	39.7	22.6	61.2	1.7	3.8	1.7	4.0	26.6	2.08	19.5	3.7	95.3	29.6	3.0
	4.0	1.8	4.2	34.7	21.5	1.51	39.8	23.0	60.0	1.7	5.6	2.9	6.6	27.7	2.11	20.5	3.8	98.4	32.7	3.1
40	4.0	1.8	4.2	34.7	21.5	1.51	39.8	23.0	60.0	1.7	7.5	4.3	10.0	28.3	2.13	21.0	3.9	97.1	34.4	3.2
	3.8	1.2	2.8	33.5	21.0	1.67	39.2	20.0	70.9	2.2	3.8	1.2	2.8	29.7	2.17	22.3	4.0	98.5	38.1	3.3
	5.6	2.2	5.1	34.2	21.4	1.57	39.6	21.8	64.1	1.8	5.6	2.2	5.1	31.0	2.21	23.5	4.1	99.8	41.7	3.5
50	7.5	3.5	8.1	34.6	21.5	1.52	39.8	22.8	60.6	1.7	7.5	3.5	8.1	31.7	2.23	24.1	4.2	100.6	43.6	3.5
	3.8	1.2	2.7	32.1	20.5	1.84	38.4	17.5	80.5	2.9	3.8	1.2	2.7	32.9	2.27	25.1	4.2	101.7	46.6	3.7
	5.6	2.0	4.6	33.1	20.9	1.72	38.9	19.2	73.8	2.4	5.6	2.0	4.6	34.4	2.31	26.5	4.4	103.3	50.6	3.9
60	7.5	3.3	7.6	33.5	21.1	1.67	39.2	20.1	70.5	2.2	7.5	3.3	7.6	35.2	2.34	27.2	4.4	104.1	52.8	4.0
	3.8	1.1	2.5	30.7	19.9	2.03	37.6	15.1	90.0	3.7	3.8	1.1	2.5	36.0	2.36	28.0	4.5	105.0	55.1	4.1
	5.6	1.9	4.5	31.7	20.3	1.90	38.1	16.7	83.6	3.1	5.6	1.9	4.5	37.7	2.41	29.4	4.6	106.7	59.5	4.4
70	7.5	3.1	7.2	32.2	20.5	1.83	38.4	17.6	80.2	2.9	7.5	3.1	7.2	38.6	2.44	30.2	4.6	107.6	61.9	4.5
	3.8	1.1	2.5	29.0	19.2	2.24	36.7	13.0	99.6	4.6	3.8	1.1	2.5	39.2	2.46	30.8	4.7	108.2	63.6	4.6
	5.6	1.9	4.4	30.1	19.7	2.09	37.3	14.4	93.2	3.9	5.6	1.9	4.4	40.9	2.52	32.4	4.8	110.0	68.5	4.9
80	7.5	3.0	7.0	30.7	19.9	2.02	37.6	15.1	90.0	3.7	6.6	2.4	5.5	41.5	2.54	32.8	4.8	110.6	70.0	5.1
	3.8	1.1	2.5	27.3	18.5	2.49	35.8	11.0	109.1	5.6	3.3	0.9	2.0	41.5	2.54	32.8	4.8	110.6	70.0	5.1
	5.6	1.9	4.3	28.4	19.0	2.32	36.4	12.2	102.9	4.9	3.3	0.9	2.0	41.5	2.54	32.8	4.8	110.6	70.0	5.1
90	7.5	2.9	6.8	29.0	19.2	2.25	36.7	12.9	99.8	4.6	3.3	0.9	2.0	41.5	2.54	32.8	4.8	110.6	70.0	5.1
	3.8	1.0	2.3	25.6	17.7	2.77	35.0	9.2	118.7	6.7	2.2	0.5	1.2	41.5	2.54	32.8	4.8	110.6	70.0	5.1
	5.6	1.8	4.1	26.7	18.2	2.59	35.5	10.3	112.6	6.0	2.2	0.5	1.2	41.5	2.54	32.8	4.8	110.6	70.0	5.1
100	7.5	2.8	6.5	27.2	18.4	2.50	35.8	10.9	109.5	5.6	2.2	0.5	1.2	41.5	2.54	32.8	4.8	110.6	70.0	5.1
	3.8	0.9	2.2	23.8	16.9	3.10	34.4	7.7	128.3	8.0	1.6	0.3	0.8	41.5	2.54	32.8	4.8	110.6	70.0	5.1
	5.6	1.7	3.9	24.9	17.4	2.89	34.8	8.6	122.4	7.2	1.6	0.3	0.8	41.5	2.54	32.8	4.8	110.6	70.0	5.1
110	7.5	2.7	6.2	25.5	17.6	2.79	35.0	9.1	119.3	6.8	1.6	0.3	0.8	41.5	2.54	32.8	4.8	110.6	70.0	5.1
	3.8	0.9	2.0	Operation Not Recommended							1.3	0.1	0.2	41.5	2.54	32.8	4.8	110.6	70.0	5.1
	5.6	1.6	3.7	23.1	16.5	3.24	34.2	7.1	132.2	8.5	1.3	0.1	0.2	41.5	2.54	32.8	4.8	110.6	70.0	5.1
120	7.5	2.6	6.0	23.7	16.8	3.13	34.4	7.6	129.2	8.1	1.3	0.1	0.2	41.5	2.54	32.8	4.8	110.6	70.0	5.1

Interpolation is permissible; extrapolation is not.

All entering air conditions are 80°F DB and 67°F WB in cooling, and 70°F DB in heating.

AHRI/ISO certified conditions are 80.6°F DB and 66.2°F WB in cooling and 68°F DB in heating.

Table does not reflect fan or pump power corrections for AHRI/ISO conditions.

All performance is based upon the lower voltage of dual voltage rated units.

Performance stated is at the rated power supply; performance may vary as the power supply varies from the rated.

Operation below 40°F EWT is based upon a 15% methanol antifreeze solution.

Operation below 60°F EWT requires optional insulated water/refrigerant circuit.

See performance correction tables for operating conditions other than those listed above.

See Performance Data Selection Notes for operation in the shaded areas.

For unit operation in the shaded area when LWT is below 40°F (4.4°C) antifreeze must be used and the JW3 jumper on the DXM2 should be clipped. This is due to the potential of the refrigerant temperature being as low as 32°F (0°C) with 40°F (4.4°C) LWT, which may lead to a nuisance cutout due to the activation of the Low Temperature Protection. JW3 should never be clipped for standard range equipment or systems without antifreeze.

Flow is controlled to maintain minimum LWT 60°F in cooling and maximum LWT 70°F in heating.

Performance Data – HE H/V 036 (Part Load) with Modulating Valve or Variable Speed Pump

950 CFM Nominal (Rated) Airflow Cooling, 950 CFM Nominal (Rated) Airflow Heating

Performance capacities shown in thousands of Btuh

EWT °F	GPM	WPD		COOLING - EAT 80/67°F							GPM	WPD		HEATING - EAT 70°F							
		PSI	FT	TC	SC	kW	HR	EER	LWT	HWC Cap		PSI	FT	HC	kW	HE	COP	LAT	LWT	HWC Cap	
20	1.7	0.1	0.2	31.1	22.0	0.98	34.5	31.6	60.0	1.2	6.0	2.4	5.5	17.0	1.66	11.3	3.0	84.5	16.2	2.5	
	30	2.3	0.1	0.2	31.1	22.0	0.98	34.5	31.6	60.0	1.2	3.0	0.1	0.3	18.5	1.66	12.8	3.3	86.0	21.5	2.6
		2.3	0.1	0.2	31.1	22.0	0.98	34.5	31.6	60.0	1.2	4.5	0.8	1.8	19.3	1.67	13.6	3.4	86.8	24.0	2.7
40	2.3	0.1	0.2	31.1	22.0	0.98	34.5	31.6	60.0	1.2	6.0	1.8	4.0	19.8	1.67	14.1	3.5	87.2	25.3	2.7	
	3.5	0.1	0.2	31.1	22.0	0.98	34.5	31.6	60.0	1.2	3.0	0.1	0.2	21.3	1.69	15.6	3.7	88.7	29.6	2.8	
		3.5	0.1	0.2	31.1	22.0	0.98	34.5	31.6	60.0	1.2	4.5	0.5	1.1	22.5	1.70	16.7	3.9	89.8	32.6	2.9
50	3.5	0.1	0.2	31.1	22.0	0.98	34.5	31.6	60.0	1.2	6.0	1.3	3.0	23.1	1.70	17.3	4.0	90.5	34.2	2.9	
	3.0	0.1	0.2	29.7	21.8	1.16	33.7	25.6	72.5	1.7	3.0	0.1	0.2	24.4	1.71	18.6	4.2	91.7	37.6	3.0	
		4.5	0.3	0.6	30.6	22.0	1.05	34.1	29.0	65.2	1.4	4.5	0.3	0.6	25.8	1.73	19.9	4.4	93.1	41.2	3.1
60	6.0	1.0	2.3	31.0	22.0	1.00	34.4	30.9	61.5	1.2	6.0	1.0	2.3	26.6	1.74	20.7	4.5	93.8	43.1	3.1	
	3.0	0.1	0.2	28.6	21.4	1.33	33.1	21.5	82.1	2.3	3.0	0.1	0.2	27.5	1.75	21.6	4.6	94.8	45.6	3.2	
		4.5	0.2	0.4	29.4	21.7	1.20	33.5	24.5	74.9	1.8	4.5	0.2	0.4	29.1	1.76	23.1	4.8	96.3	49.8	3.3
70	6.0	0.8	1.9	29.9	21.9	1.14	33.8	26.1	71.3	1.6	6.0	0.8	1.9	29.9	1.77	23.8	4.9	97.1	52.1	3.4	
	3.0	0.1	0.2	27.4	20.7	1.53	32.6	17.8	91.7	3.0	3.0	0.1	0.2	30.5	1.78	24.4	5.0	97.6	53.7	3.4	
		4.5	0.2	0.4	28.3	21.2	1.38	33.0	20.4	84.7	2.5	4.5	0.2	0.4	31.9	1.80	25.8	5.2	99.1	58.5	3.6
80	6.0	0.7	1.7	28.7	21.4	1.31	33.2	21.9	81.1	2.2	6.0	0.7	1.7	32.6	1.81	26.5	5.3	99.7	61.2	3.7	
	3.0	0.1	0.2	26.0	20.0	1.77	32.0	14.7	101.4	3.9	3.0	0.1	0.2	32.9	1.81	26.7	5.3	100.0	62.2	3.7	
		4.5	0.2	0.4	27.0	20.5	1.60	32.4	16.9	94.4	3.3	4.5	0.2	0.4	34.0	1.82	27.8	5.5	101.1	67.6	3.9
90	6.0	0.7	1.6	27.5	20.8	1.51	32.6	18.1	90.9	3.0	5.6	0.5	1.3	34.3	1.82	28.1	5.5	101.4	70.0	4.0	
	3.0	0.1	0.2	24.5	19.2	2.03	31.4	12.1	110.9	5.0	2.8	0.1	0.2	34.3	1.82	28.1	5.5	101.4	70.0	4.0	
		4.5	0.2	0.4	25.6	19.7	1.84	31.8	13.9	104.2	4.2	2.8	0.1	0.2	34.3	1.82	28.1	5.5	101.4	70.0	4.0
100	6.0	0.7	1.6	26.1	20.0	1.75	32.1	14.9	100.7	3.9	2.8	0.1	0.2	34.3	1.82	28.1	5.5	101.4	70.0	4.0	
	3.0	0.1	0.2	22.7	18.5	2.32	30.6	9.8	120.4	6.2	1.9	0.1	0.2	34.3	1.82	28.1	5.5	101.4	70.0	4.0	
		4.5	0.2	0.4	23.9	19.0	2.12	31.2	11.3	113.9	5.4	1.9	0.1	0.2	34.3	1.82	28.1	5.5	101.4	70.0	4.0
110	6.0	0.7	1.6	24.5	19.2	2.02	31.4	12.2	110.5	4.9	1.9	0.1	0.2	34.3	1.82	28.1	5.5	101.4	70.0	4.0	
	3.0	0.1	0.2	20.7	17.7	2.64	29.7	7.8	129.8	7.5	1.4	0.1	0.2	34.3	1.82	28.1	5.5	101.4	70.0	4.0	
		4.5	0.2	0.4	22.1	18.2	2.42	30.3	9.1	123.5	6.6	1.4	0.1	0.2	34.3	1.82	28.1	5.5	101.4	70.0	4.0
120	6.0	0.7	1.6	22.7	18.5	2.31	30.6	9.8	120.2	6.2	1.4	0.1	0.2	34.3	1.82	28.1	5.5	101.4	70.0	4.0	
	3.0	0.1	0.2	18.4	16.9	2.99	28.6	6.1	139.1	9.0	1.1	0.1	0.2	34.3	1.82	28.1	5.5	101.4	70.0	4.0	
		4.5	0.2	0.4	19.9	17.5	2.76	29.3	7.2	133.0	8.0	1.1	0.1	0.2	34.3	1.82	28.1	5.5	101.4	70.0	4.0
6.0	0.6	1.5	20.7	17.7	2.65	29.7	7.8	129.9	7.6	1.1	0.1	0.2	34.3	1.82	28.1	5.5	101.4	70.0	4.0		

Interpolation is permissible; extrapolation is not.

All entering air conditions are 80°F DB and 67°F WB in cooling, and 70°F DB in heating.

AHRI/ISO certified conditions are 80.6°F DB and 66.2°F WB in cooling and 68°F DB in heating.

Table does not reflect fan or pump power corrections for AHRI/ISO conditions.

All performance is based upon the lower voltage of dual voltage rated units.

Performance stated is at the rated power supply; performance may vary as the power supply varies from the rated.

Operation below 40°F EWT is based upon a 15% methanol antifreeze solution.

Operation below 60°F EWT requires optional insulated water/refrigerant circuit.

See performance correction tables for operating conditions other than those listed above.

See Performance Data Selection Notes for operation in the shaded areas.

For unit operation in the shaded area when LWT is below 40°F (4.4°C) antifreeze must be used and the JW3 jumper on the DXM2 should be clipped. This is due to the potential of the refrigerant temperature being as low as 32°F (0°C) with 40°F (4.4°C) LWT, which may lead to a nuisance cutout due to the activation of the Low Temperature Protection. JW3 should never be clipped for standard range equipment or systems without antifreeze.

Flow is controlled to maintain minimum LWT 60°F in cooling and maximum LWT 70°F in heating.

Performance Data – HE H/V 036 (Full Load) with Modulating Valve or Variable Speed Pump

1,150 CFM Nominal (Rated) Airflow Cooling, 1,150 CFM Nominal (Rated) Airflow Heating

Performance capacities shown in thousands of Btuh

EWT °F	GPM	WPD		COOLING - EAT 80/67°F							GPM	WPD		HEATING - EAT 70°F						
		PSI	FT	TC	SC	kW	HR	EER	LWT	HWC Cap		PSI	FT	HC	kW	HE	COP	LAT	LWT	HWC Cap
20	2.3	0.2	0.4	40.8	27.6	1.69	46.6	24.1	60.0	1.8	9.0	4.9	11.4	25.1	2.31	17.3	3.2	88.2	16.2	3.3
	3.1	0.1	0.3	40.8	27.6	1.69	46.6	24.1	60.0	1.8	4.5	0.8	1.9	27.3	2.36	19.2	3.4	89.9	21.5	3.4
	3.1	0.1	0.3	40.8	27.6	1.69	46.6	24.1	60.0	1.8	6.8	2.3	5.4	28.4	2.38	20.3	3.5	90.8	24.0	3.5
30	3.1	0.1	0.3	40.8	27.6	1.69	46.6	24.1	60.0	1.8	9.0	4.0	9.3	29.0	2.40	20.9	3.6	91.3	25.4	3.5
	4.5	0.5	1.1	40.8	27.6	1.70	46.6	24.0	60.7	1.8	4.5	0.5	1.1	31.1	2.44	22.8	3.7	93.0	29.9	3.7
	4.7	0.6	1.3	40.8	27.6	1.69	46.6	24.1	60.0	1.8	6.8	1.8	4.2	32.6	2.47	24.2	3.9	94.2	32.8	3.8
40	4.7	0.6	1.3	40.8	27.6	1.69	46.6	24.1	60.0	1.8	9.0	3.4	7.8	33.4	2.49	24.9	3.9	94.8	34.5	3.9
	4.5	0.2	0.5	40.0	27.4	1.84	46.3	21.7	70.6	2.4	4.5	0.2	0.5	35.2	2.53	26.6	4.1	96.3	38.2	4.1
	6.8	1.5	3.4	40.6	27.5	1.74	46.5	23.3	63.8	2.0	6.8	1.5	3.4	37.0	2.56	28.2	4.2	97.7	41.6	4.2
50	9.0	2.9	6.7	40.8	27.6	1.70	46.6	24.1	60.4	1.8	9.0	2.9	6.7	37.9	2.59	29.1	4.3	98.4	43.5	4.3
	4.5	0.1	0.3	38.8	26.9	2.02	45.7	19.1	80.3	3.2	4.5	0.1	0.3	39.3	2.62	30.4	4.4	99.6	46.5	4.5
	6.8	1.2	2.9	39.6	27.2	1.90	46.1	20.9	73.7	2.6	6.8	1.2	2.9	41.2	2.68	32.1	4.5	101.1	50.5	4.8
60	9.0	2.6	5.9	40.0	27.4	1.84	46.3	21.7	70.3	2.4	9.0	2.6	5.9	42.2	2.71	33.0	4.6	101.9	52.7	4.9
	4.5	0.1	0.3	37.3	26.3	2.24	44.9	16.6	90.0	4.2	4.5	0.1	0.3	43.2	2.75	33.8	4.6	102.7	55.0	5.0
	6.8	1.1	2.6	38.3	26.7	2.09	45.4	18.3	83.5	3.5	6.8	1.1	2.6	45.1	2.83	35.4	4.7	104.2	59.5	5.4
70	9.0	2.4	5.5	38.8	26.9	2.02	45.7	19.2	80.2	3.1	9.0	2.4	5.5	46.0	2.87	36.2	4.7	105.0	62.0	5.5
	4.5	0.1	0.3	35.5	25.5	2.51	44.1	14.2	99.6	5.4	4.5	0.1	0.3	46.6	2.91	36.7	4.7	105.5	63.7	5.7
	6.8	1.1	2.5	36.7	26.0	2.33	44.6	15.8	93.2	4.6	6.8	1.1	2.5	48.2	3.02	37.9	4.7	106.7	68.8	6.1
80	9.0	2.3	5.3	37.3	26.3	2.24	44.9	16.6	90.0	4.2	7.6	1.5	3.5	48.5	3.05	38.1	4.7	107.0	70.0	6.2
	4.5	0.2	0.4	33.5	24.6	2.82	43.1	11.9	109.2	6.8	3.8	0.1	0.2	48.5	3.05	38.1	4.7	107.0	70.0	6.2
	6.8	1.1	2.5	34.8	25.2	2.61	43.7	13.3	103.0	5.9	3.8	0.1	0.2	48.5	3.05	38.1	4.7	107.0	70.0	6.2
90	9.0	2.3	5.2	35.5	25.5	2.51	44.0	14.1	99.8	5.4	3.8	0.1	0.2	48.5	3.05	38.1	4.7	107.0	70.0	6.2
	4.5	0.2	0.5	31.4	23.7	3.18	42.2	9.9	118.8	8.5	2.5	0.1	0.2	48.5	3.05	38.1	4.7	107.0	70.0	6.2
	6.8	1.1	2.5	32.8	24.3	2.94	42.8	11.1	112.7	7.4	2.5	0.1	0.2	48.5	3.05	38.1	4.7	107.0	70.0	6.2
100	9.0	2.3	5.2	33.4	24.6	2.83	43.1	11.8	109.6	6.9	2.5	0.1	0.2	48.5	3.05	38.1	4.7	107.0	70.0	6.2
	4.5	0.2	0.4	29.1	22.8	3.60	41.4	8.1	128.4	10.4	1.9	0.1	0.2	48.5	3.05	38.1	4.7	107.0	70.0	6.2
	6.8	1.1	2.5	30.5	23.4	3.33	41.9	9.2	122.4	9.2	1.9	0.1	0.2	48.5	3.05	38.1	4.7	107.0	70.0	6.2
110	9.0	2.3	5.2	31.2	23.7	3.21	42.2	9.7	119.4	8.6	1.9	0.1	0.2	48.5	3.05	38.1	4.7	107.0	70.0	6.2
	4.5	0.1	0.2	26.8	21.8	4.09	40.7	6.5	138.1	12.6	1.5	0.1	0.2	48.5	3.05	38.1	4.7	107.0	70.0	6.2
	6.8	1.0	2.3	28.2	22.4	3.79	41.1	7.5	132.2	11.2	1.5	0.1	0.2	48.5	3.05	38.1	4.7	107.0	70.0	6.2
120	9.0	2.2	5.1	28.9	22.7	3.64	41.4	7.9	129.2	10.6	1.5	0.1	0.2	48.5	3.05	38.1	4.7	107.0	70.0	6.2

Interpolation is permissible; extrapolation is not.

All entering air conditions are 80°F DB and 67°F WB in cooling, and 70°F DB in heating.

AHRI/ISO certified conditions are 80.6°F DB and 66.2°F WB in cooling and 68°F DB in heating.

Table does not reflect fan or pump power corrections for AHRI/ISO conditions.

All performance is based upon the lower voltage of dual voltage rated units.

Performance stated is at the rated power supply; performance may vary as the power supply varies from the rated.

Operation below 40°F EWT is based upon a 15% methanol antifreeze solution.

Operation below 60°F EWT requires optional insulated water/refrigerant circuit.

See performance correction tables for operating conditions other than those listed above.

See Performance Data Selection Notes for operation in the shaded areas.

For unit operation in the shaded area when LWT is below 40°F (4.4°C) antifreeze must be used and the JW3 jumper on the DXM2 should be clipped. This is due to the potential of the refrigerant temperature being as low as 32°F (0°C) with 40°F (4.4°C) LWT, which may lead to a nuisance cutout due to the activation of the Low Temperature Protection. JW3 should never be clipped for standard range equipment or systems without antifreeze.

Flow is controlled to maintain minimum LWT 60°F in cooling and maximum LWT 70°F in heating.

Performance Data – HE H/V 042 (Part Load) with Modulating Valve or Variable Speed Pump

1,100 CFM Nominal (Rated) Airflow Cooling, 1,100 CFM Nominal (Rated) Airflow Heating

Performance capacities shown in thousands of Btuh

EWT °F	GPM	WPD		COOLING - EAT 80/67°F							GPM	WPD		HEATING - EAT 70°F						
		PSI	FT	TC	SC	kW	HR	EER	LWT	HWC Cap		PSI	FT	HC	kW	HE	COP	LAT	LWT	HWC Cap
20	2.1	1.1	2.6	37.6	28.3	1.26	41.9	29.8	60.0	1.2	7.5	5.0	11.7	19.8	2.09	12.7	2.8	16.6	16.6	2.5
	2.8	1.1	2.5	37.6	28.3	1.26	41.9	29.8	60.0	1.2	3.8	1.7	3.9	22.1	2.12	14.9	3.1	22.1	22.1	2.6
	2.8	1.1	2.5	37.6	28.3	1.26	41.9	29.8	60.0	1.2	5.6	2.9	6.7	23.1	2.13	15.8	3.2	24.4	24.4	2.7
30	2.8	1.1	2.5	37.6	28.3	1.26	41.9	29.8	60.0	1.2	7.5	4.5	10.3	23.7	2.14	16.4	3.2	25.6	25.6	2.7
	3.8	1.4	3.2	37.4	28.5	1.31	41.8	28.6	62.3	1.2	3.8	1.4	3.2	25.6	2.16	18.3	3.5	30.3	30.3	2.8
	4.2	1.6	3.7	37.6	28.3	1.26	41.9	29.8	60.0	1.2	5.6	2.4	5.6	26.8	2.17	19.4	3.6	33.1	33.1	2.9
40	4.2	1.6	3.7	37.6	28.3	1.26	41.9	29.8	60.0	1.2	7.5	3.8	8.8	27.5	2.18	20.1	3.7	34.6	34.6	2.9
	3.8	1.0	2.4	36.3	27.9	1.49	41.4	24.3	72.1	1.6	3.8	1.0	2.4	29.1	2.19	21.6	3.9	38.5	38.5	3.0
	5.6	2.0	4.5	37.1	28.4	1.35	41.7	27.5	64.8	1.3	5.6	2.0	4.5	30.5	2.20	23.0	4.1	41.8	41.8	3.1
50	7.5	3.1	7.2	37.5	28.6	1.29	41.9	29.2	61.2	1.2	7.5	3.1	7.2	31.3	2.21	23.8	4.2	43.7	43.7	3.1
	3.8	1.0	2.3	34.8	27.1	1.71	40.7	20.4	81.7	2.2	3.8	1.0	2.3	32.5	2.22	25.0	4.3	46.7	46.7	3.2
	5.6	1.8	4.2	35.9	27.7	1.55	41.2	23.2	74.6	1.8	5.6	1.8	4.2	34.1	2.23	26.5	4.5	50.6	50.6	3.4
60	7.5	3.0	6.9	36.4	28.0	1.47	41.4	24.7	71.0	1.6	7.5	3.0	6.9	35.0	2.24	27.3	4.6	52.7	52.7	3.4
	3.8	0.9	2.1	33.1	26.2	1.95	39.8	16.9	91.2	3.0	3.8	0.9	2.1	35.9	2.25	28.2	4.7	54.9	54.9	3.5
	5.6	1.7	4.0	34.4	26.8	1.78	40.4	19.3	84.4	2.4	5.6	1.7	4.0	37.6	2.26	29.9	4.9	59.4	59.4	3.6
70	7.5	2.8	6.5	35.0	27.2	1.69	40.7	20.7	80.9	2.2	7.5	2.8	6.5	38.6	2.27	30.8	5.0	61.8	61.8	3.7
	3.8	0.9	2.1	31.1	25.3	2.22	38.7	14.0	100.7	4.0	3.8	0.9	2.1	39.1	2.27	31.4	5.1	63.3	63.3	3.8
	5.6	1.7	3.9	32.5	25.9	2.03	39.5	16.0	94.0	3.3	5.6	1.7	3.9	41.0	2.28	33.2	5.3	68.2	68.2	4.0
80	7.5	2.7	6.3	33.2	26.2	1.94	39.8	17.1	90.6	3.0	6.8	2.2	5.2	41.6	2.29	33.8	5.3	102.9	70.0	4.1
	3.8	0.9	2.0	29.0	24.4	2.51	37.6	11.5	110.1	5.2	3.4	0.9	2.0	41.6	2.29	33.8	5.3	102.9	70.0	4.1
	5.6	1.6	3.8	30.5	25.0	2.31	38.4	13.2	103.6	4.4	3.4	0.9	2.0	41.6	2.29	33.8	5.3	102.9	70.0	4.1
90	7.5	2.6	6.1	31.2	25.3	2.21	38.8	14.1	100.3	4.0	3.4	0.9	2.0	41.6	2.29	33.8	5.3	102.9	70.0	4.1
	3.8	0.9	2.0	26.8	23.5	2.83	36.4	9.5	119.4	6.5	2.3	0.6	1.5	41.6	2.29	33.8	5.3	102.9	70.0	4.1
	5.6	1.6	3.6	28.3	24.1	2.62	37.2	10.8	113.2	5.6	2.3	0.6	1.5	41.6	2.29	33.8	5.3	102.9	70.0	4.1
100	7.5	2.6	5.9	29.0	24.4	2.51	37.6	11.5	110.0	5.2	2.3	0.6	1.5	41.6	2.29	33.8	5.3	102.9	70.0	4.1
	3.8	0.8	1.9	24.5	22.7	3.16	35.3	7.7	128.8	8.1	1.7	0.5	1.2	41.6	2.29	33.8	5.3	102.9	70.0	4.1
	5.6	1.5	3.5	26.0	23.2	2.94	36.0	8.8	122.8	7.1	1.7	0.5	1.2	41.6	2.29	33.8	5.3	102.9	70.0	4.1
110	7.5	2.5	5.7	26.7	23.5	2.84	36.4	9.4	119.7	6.6	1.7	0.5	1.2	41.6	2.29	33.8	5.3	102.9	70.0	4.1
	3.8	0.8	1.8	Operation Not Recommended							1.4	0.3	0.7	41.6	2.29	33.8	5.3	102.9	70.0	4.1
	5.6	1.5	3.4	23.6	22.4	3.29	34.8	7.2	132.4	8.7	1.4	0.3	0.7	41.6	2.29	33.8	5.3	102.9	70.0	4.1
120	7.5	2.4	5.5	24.3	22.7	3.18	35.2	7.6	129.4	8.2	1.4	0.3	0.7	41.6	2.29	33.8	5.3	102.9	70.0	4.1

Interpolation is permissible; extrapolation is not.

All entering air conditions are 80°F DB and 67°F WB in cooling, and 70°F DB in heating.

AHRI/ISO certified conditions are 80.6°F DB and 66.2°F WB in cooling and 68°F DB in heating.

Table does not reflect fan or pump power corrections for AHRI/ISO conditions.

All performance is based upon the lower voltage of dual voltage rated units.

Performance stated is at the rated power supply; performance may vary as the power supply varies from the rated.

Operation below 40°F EWT is based upon a 15% methanol antifreeze solution.

Operation below 60°F EWT requires optional insulated water/refrigerant circuit.

See performance correction tables for operating conditions other than those listed above.

See Performance Data Selection Notes for operation in the shaded areas.

For unit operation in the shaded area when LWT is below 40°F (4.4°C) antifreeze must be used and the JW3 jumper on the DXM2 should be clipped. This is due to the potential of the refrigerant temperature being as low as 32°F (0°C) with 40°F (4.4°C) LWT, which may lead to a nuisance cutout due to the activation of the Low Temperature Protection. JW3 should never be clipped for standard range equipment or systems without antifreeze.

Flow is controlled to maintain minimum LWT 60°F in cooling and maximum LWT 70°F in heating.

Performance Data – HE H/V 042 (Full Load) with Modulating Valve or Variable Speed Pump

1,300 CFM Nominal (Rated) Airflow Cooling, 1,300 CFM Nominal (Rated) Airflow Heating

Performance capacities shown in thousands of Btuh

EWT °F	GPM	WPD		COOLING - EAT 80/67°F								GPM	WPD		HEATING - EAT 70°F							
		PSI	FT	TC	SC	kW	HR	EER	LWT	HWC Cap	PSI		FT	HC	kW	HE	COP	LAT	LWT	HWC Cap		
20	2.8	1.5	3.4	49.4	36.1	2.09	56.6	23.6	60.0	1.7	10.5	8.4	19.4	29.6	2.83	19.9	3.1	89.0	16.2	3.3		
	3.8	1.6	3.6	49.4	36.1	2.09	56.6	23.6	60.0	1.7	5.3	2.7	6.2	32.4	2.89	22.5	3.3	91.0	21.4	3.4		
	3.8	1.6	3.6	49.4	36.1	2.09	56.6	23.6	60.0	1.7	7.9	4.8	11.1	33.7	2.93	23.7	3.4	92.0	24.0	3.5		
30	3.8	1.6	3.6	49.4	36.1	2.09	56.6	23.6	60.0	1.7	10.5	7.4	17.0	34.4	2.94	24.4	3.4	92.5	25.4	3.6		
	5.3	1.8	4.1	49.2	35.9	2.12	56.4	23.2	61.5	1.8	5.3	1.8	4.1	36.9	3.00	26.6	3.6	94.2	29.9	3.7		
	5.7	2.2	5.1	49.4	36.1	2.09	56.6	23.6	60.0	1.7	7.9	4.1	9.5	38.5	3.04	28.1	3.7	95.3	32.9	3.8		
40	5.7	2.2	5.1	49.4	36.1	2.09	56.6	23.6	60.0	1.7	10.5	6.4	14.7	39.3	3.06	28.9	3.8	95.9	34.5	3.9		
	5.3	1.8	4.1	47.8	35.0	2.32	55.7	20.6	71.2	2.3	5.3	1.8	4.1	41.3	3.11	30.7	3.9	97.4	38.3	4.1		
	7.9	3.4	7.9	48.8	35.7	2.17	56.2	22.5	64.3	1.9	7.9	3.4	7.9	43.2	3.15	32.4	4.0	98.7	41.8	4.2		
50	10.5	5.4	12.5	49.3	36.0	2.11	56.5	23.4	60.8	1.7	10.5	5.4	12.5	44.1	3.18	33.3	4.1	99.4	43.7	4.3		
	5.3	1.7	3.9	46.1	34.1	2.55	54.7	18.1	80.9	3.0	5.3	1.7	3.9	45.8	3.22	34.8	4.2	100.5	46.7	4.5		
	7.9	3.2	7.5	47.3	34.8	2.38	55.4	19.8	74.1	2.5	7.9	3.2	7.5	47.8	3.27	36.6	4.3	102.0	50.7	4.7		
60	10.5	5.2	11.9	47.9	35.1	2.31	55.7	20.7	70.6	2.3	10.5	5.2	11.9	48.9	3.30	37.6	4.3	102.8	52.8	4.9		
	5.3	1.6	3.6	44.1	33.1	2.81	53.7	15.7	90.5	3.8	5.3	1.6	3.6	50.1	3.33	38.8	4.4	103.6	55.2	5.0		
	7.9	3.1	7.1	45.5	33.8	2.62	54.4	17.3	83.8	3.2	7.9	3.1	7.1	52.4	3.39	40.8	4.5	105.2	59.6	5.3		
70	10.5	4.9	11.3	46.1	34.1	2.54	54.8	18.2	80.4	3.0	10.5	4.9	11.3	53.5	3.42	41.9	4.6	106.0	62.0	5.5		
	5.3	1.5	3.5	42.0	32.2	3.10	52.6	13.5	100.0	4.7	5.3	1.5	3.5	54.4	3.45	42.6	4.6	106.7	63.8	5.6		
	7.9	3.0	6.9	43.5	32.8	2.90	53.3	15.0	93.5	4.1	7.9	3.0	6.9	56.8	3.52	44.8	4.7	108.3	68.6	6.0		
80	10.5	4.8	11.0	44.2	33.1	2.80	53.7	15.8	90.2	3.8	9.1	3.7	8.5	57.4	3.53	45.4	4.8	108.8	70.0	6.1		
	5.3	1.5	3.4	39.6	31.3	3.44	51.4	11.5	109.6	5.8	4.5	1.2	2.8	57.4	3.53	45.4	4.8	108.8	70.0	6.1		
	7.9	2.9	6.6	41.2	31.8	3.21	52.2	12.8	103.3	5.1	4.5	1.2	2.8	57.4	3.53	45.4	4.8	108.8	70.0	6.1		
90	10.5	4.7	10.7	42.0	32.2	3.10	52.6	13.5	100.0	4.7	4.5	1.2	2.8	57.4	3.53	45.4	4.8	108.8	70.0	6.1		
	5.3	1.4	3.3	37.1	30.4	3.82	50.2	9.7	119.1	6.9	3.0	0.8	1.8	57.4	3.53	45.4	4.8	108.8	70.0	6.1		
	7.9	2.8	6.4	38.8	31.0	3.57	51.0	10.9	112.9	6.2	3.0	0.8	1.8	57.4	3.53	45.4	4.8	108.8	70.0	6.1		
100	10.5	4.5	10.4	39.6	31.2	3.45	51.4	11.5	109.8	5.8	3.0	0.8	1.8	57.4	3.53	45.4	4.8	108.8	70.0	6.1		
	5.3	1.4	3.2	34.5	29.6	4.26	49.0	8.1	128.7	8.2	2.3	0.6	1.3	57.4	3.53	45.4	4.8	108.8	70.0	6.1		
	7.9	2.7	6.2	36.2	30.1	3.98	49.7	9.1	122.6	7.4	2.3	0.6	1.3	57.4	3.53	45.4	4.8	108.8	70.0	6.1		
110	10.5	4.4	10.1	37.0	30.4	3.84	50.1	9.6	119.5	7.0	2.3	0.6	1.3	57.4	3.53	45.4	4.8	108.8	70.0	6.1		
	5.3	1.3	3.1	Operation Not Recommended							1.8	0.3	0.8	57.4	3.53	45.4	4.8	108.8	70.0	6.1		
	7.9	2.6	6.0	33.4	29.3	4.44	48.5	7.5	132.3	8.8	1.8	0.3	0.8	57.4	3.53	45.4	4.8	108.8	70.0	6.1		
120	10.5	4.2	9.8	34.3	29.6	4.29	48.9	8.0	129.3	8.3	1.8	0.3	0.8	57.4	3.53	45.4	4.8	108.8	70.0	6.1		

Interpolation is permissible; extrapolation is not.

All entering air conditions are 80°F DB and 67°F WB in cooling, and 70°F DB in heating.

AHRI/ISO certified conditions are 80.6°F DB and 66.2°F WB in cooling and 68°F DB in heating.

Table does not reflect fan or pump power corrections for AHRI/ISO conditions.

All performance is based upon the lower voltage of dual voltage rated units.

Performance stated is at the rated power supply; performance may vary as the power supply varies from the rated.

Operation below 40°F EWT is based upon a 15% methanol antifreeze solution.

Operation below 60°F EWT requires optional insulated water/refrigerant circuit.

See performance correction tables for operating conditions other than those listed above.

See Performance Data Selection Notes for operation in the shaded areas.

For unit operation in the shaded area when LWT is below 40°F (4.4°C) antifreeze must be used and the JW3 jumper on the DXM2 should be clipped. This is due to the potential of the refrigerant temperature being as low as 32°F (0°C) with 40°F (4.4°C) LWT, which may lead to a nuisance cutout due to the activation of the Low Temperature Protection. JW3 should never be clipped for standard range equipment or systems without antifreeze.

Flow is controlled to maintain minimum LWT 60°F in cooling and maximum LWT 70°F in heating.

Performance Data – HE H/V 048 (Part Load) with Modulating Valve or Variable Speed Pump

1,250 CFM Nominal (Rated) Airflow Cooling, 1,250 CFM Nominal (Rated) Airflow Heating

Performance capacities shown in thousands of Btuh

EWT °F	GPM	WPD		COOLING - EAT 80/67°F								GPM	WPD		HEATING - EAT 70°F							
		PSI	FT	TC	SC	kW	HR	EER	LWT	HWC Cap	PSI		FT	HC	kW	HE	COP	LAT	LWT	HWC Cap		
20	2.3	0.7	1.6	41.2	28.3	1.50	46.3	27.5	60.0	1.5	9.0	5.2	12.1	23.0	2.18	15.6	3.1	85.0	16.5	3.0		
	3.1	0.7	1.7	41.2	28.3	1.50	46.3	27.5	60.0	1.5	4.5	1.4	3.2	25.3	2.20	17.8	3.4	86.7	22.1	3.0		
	3.1	0.7	1.7	41.2	28.3	1.50	46.3	27.5	60.0	1.5	6.8	2.5	5.7	26.3	2.20	18.8	3.5	87.4	24.4	3.1		
30	3.1	0.7	1.7	41.2	28.3	1.50	46.3	27.5	60.0	1.5	9.0	4.0	9.2	26.8	2.21	19.3	3.6	87.8	25.7	3.1		
	4.5	1.2	2.8	41.1	28.3	1.51	46.3	27.3	60.6	1.5	4.5	1.2	2.8	28.8	2.22	21.3	3.8	89.3	30.5	3.1		
	4.6	1.3	2.9	41.2	28.3	1.50	46.3	27.5	60.0	1.5	6.8	2.4	5.5	30.0	2.22	22.4	4.0	90.2	33.4	3.2		
40	4.6	1.3	2.9	41.2	28.3	1.50	46.3	27.5	60.0	1.5	9.0	3.8	8.7	30.7	2.23	23.1	4.0	90.7	34.9	3.2		
	4.5	1.1	2.5	39.9	27.8	1.72	45.7	23.3	70.3	2.1	4.5	1.1	2.5	32.4	2.24	24.8	4.3	92.0	39.0	3.3		
	6.8	2.1	4.9	40.8	28.2	1.57	46.1	26.0	63.7	1.7	6.8	2.1	4.9	33.8	2.24	26.2	4.4	93.0	42.2	3.4		
50	9.0	3.4	7.9	41.2	28.3	1.50	46.3	27.4	60.3	1.5	9.0	3.4	7.9	34.6	2.25	26.9	4.5	93.6	44.0	3.4		
	4.5	1.0	2.3	38.3	27.2	1.98	45.1	19.4	80.0	2.9	4.5	1.0	2.3	36.1	2.25	28.4	4.7	94.6	47.4	3.5		
	6.8	2.0	4.6	39.4	27.6	1.79	45.5	22.0	73.5	2.4	6.8	2.0	4.6	37.7	2.26	29.9	4.9	95.8	51.1	3.6		
60	9.0	3.2	7.5	39.9	27.9	1.71	45.8	23.3	70.2	2.1	9.0	3.2	7.5	38.5	2.26	30.8	5.0	96.5	53.2	3.7		
	4.5	0.9	2.0	36.5	26.3	2.28	44.2	16.0	89.7	3.9	4.5	0.9	2.0	39.7	2.27	31.9	5.1	97.3	55.8	3.7		
	6.8	1.8	4.2	37.7	26.9	2.07	44.8	18.2	83.3	3.2	6.8	1.8	4.2	41.4	2.28	33.7	5.3	98.6	60.0	3.9		
70	9.0	3.0	6.9	38.3	27.2	1.97	45.1	19.4	80.0	2.9	9.0	3.0	6.9	42.4	2.28	34.6	5.4	99.3	62.3	4.0		
	4.5	0.9	2.0	34.4	25.4	2.63	43.3	13.1	99.3	5.1	4.5	0.9	2.0	43.2	2.28	35.4	5.5	99.9	64.3	4.0		
	6.8	1.8	4.0	35.8	26.0	2.40	43.9	14.9	93.0	4.3	6.8	1.8	4.0	45.1	2.29	37.3	5.8	101.3	68.9	4.2		
80	9.0	2.9	6.7	36.4	26.3	2.29	44.2	15.9	89.8	3.9	7.5	2.1	4.8	45.5	2.29	37.7	5.8	101.7	70.0	4.3		
	4.5	0.8	1.8	32.1	24.5	3.01	42.4	10.7	108.8	6.4	3.8	0.7	1.6	45.5	2.29	37.7	5.8	101.7	70.0	4.3		
	6.8	1.7	3.9	33.6	25.1	2.76	43.0	12.2	102.7	5.5	3.8	0.7	1.6	45.5	2.29	37.7	5.8	101.7	70.0	4.3		
90	9.0	2.8	6.5	34.3	25.4	2.64	43.3	13.0	99.6	5.1	3.8	0.7	1.6	45.5	2.29	37.7	5.8	101.7	70.0	4.3		
	4.5	0.8	1.8	29.7	23.5	3.42	41.4	8.7	118.4	8.0	2.5	0.4	1.0	45.5	2.29	37.7	5.8	101.7	70.0	4.3		
	6.8	1.6	3.7	31.2	24.1	3.16	42.0	9.9	112.4	7.0	2.5	0.4	1.0	45.5	2.29	37.7	5.8	101.7	70.0	4.3		
100	9.0	2.7	6.1	32.0	24.4	3.03	42.3	10.5	109.4	6.5	2.5	0.4	1.0	45.5	2.29	37.7	5.8	101.7	70.0	4.3		
	4.5	0.7	1.7	27.3	22.6	3.86	40.4	7.1	128.0	9.8	1.9	0.3	0.7	45.5	2.29	37.7	5.8	101.7	70.0	4.3		
	6.8	1.5	3.5	28.8	23.2	3.59	41.0	8.0	122.2	8.7	1.9	0.3	0.7	45.5	2.29	37.7	5.8	101.7	70.0	4.3		
110	9.0	2.6	5.9	29.5	23.4	3.46	41.3	8.5	119.2	8.2	1.9	0.3	0.7	45.5	2.29	37.7	5.8	101.7	70.0	4.3		
	4.5	0.7	1.7	24.8	21.8	4.32	39.5	5.8	137.6	11.8	1.5	0.1	0.3	45.5	2.29	37.7	5.8	101.7	70.0	4.3		
	6.8	1.5	3.5	26.3	22.3	4.04	40.1	6.5	131.9	10.6	1.5	0.1	0.3	45.5	2.29	37.7	5.8	101.7	70.0	4.3		
120	9.0	2.5	5.9	27.0	22.5	3.90	40.4	6.9	129.0	10.0	1.5	0.1	0.3	45.5	2.29	37.7	5.8	101.7	70.0	4.3		

Interpolation is permissible; extrapolation is not.

All entering air conditions are 80°F DB and 67°F WB in cooling, and 70°F DB in heating.

AHRI/ISO certified conditions are 80.6°F DB and 66.2°F WB in cooling and 68°F DB in heating.

Table does not reflect fan or pump power corrections for AHRI/ISO conditions.

All performance is based upon the lower voltage of dual voltage rated units.

Performance stated is at the rated power supply; performance may vary as the power supply varies from the rated.

Operation below 40°F EWT is based upon a 15% methanol antifreeze solution.

Operation below 60°F EWT requires optional insulated water/refrigerant circuit.

See performance correction tables for operating conditions other than those listed above.

See Performance Data Selection Notes for operation in the shaded areas.

For unit operation in the shaded area when LWT is below 40°F (4.4°C) antifreeze must be used and the JW3 jumper on the DXM2 should be clipped. This is due to the potential of the refrigerant temperature being as low as 32°F (0°C) with 40°F (4.4°C) LWT, which may lead to a nuisance cutout due to the activation of the Low Temperature Protection. JW3 should never be clipped for standard range equipment or systems without antifreeze.

Flow is controlled to maintain minimum LWT 60°F in cooling and maximum LWT 70°F in heating.

Performance Data – HE H/V 048 (Full Load) with Modulating Valve or Variable Speed Pump

1,500 CFM Nominal (Rated) Airflow Cooling, 1,500 CFM Nominal (Rated) Airflow Heating

Performance capacities shown in thousands of Btuh

EWT °F	GPM	WPD		COOLING - EAT 80/67°F								GPM	WPD		HEATING - EAT 70°F							
		PSI	FT	TC	SC	kW	HR	EER	LWT	HWC Cap	PSI		FT	HC	kW	HE	COP	LAT	LWT	HWC Cap		
20	3.1	1.1	2.5	54.1	36.1	2.36	62.2	23.0	60.0	2.5	12.0	7.7	17.8	32.4	2.88	22.6	3.3	88.0	16.2	3.5		
	30	4.1	1.2	2.8	54.1	36.1	2.36	62.2	23.0	60.0	2.5	6.0	2.0	4.6	35.2	2.93	25.1	3.5	89.6	21.6	3.6	
		4.1	1.2	2.8	54.1	36.1	2.36	62.2	23.0	60.0	2.5	9.0	4.0	9.2	36.5	2.96	26.4	3.6	90.5	24.1	3.7	
40	4.1	1.2	2.8	54.1	36.1	2.36	62.2	23.0	60.0	2.5	12.0	6.5	15.1	37.2	2.97	27.0	3.7	90.9	25.5	3.8		
	40	6.0	1.9	4.4	54.1	36.1	2.37	62.2	22.8	60.7	2.5	6.0	1.9	4.4	39.7	3.02	29.4	3.9	92.5	30.2	3.9	
		6.2	2.0	4.7	54.1	36.1	2.36	62.2	23.0	60.0	2.5	9.0	3.8	8.7	41.4	3.05	30.9	4.0	93.5	33.1	4.0	
50	6.2	2.0	4.7	54.1	36.1	2.36	62.2	23.0	60.0	2.5	12.0	6.0	13.9	42.3	3.07	31.8	4.0	94.0	34.7	4.1		
	50	6.0	1.7	4.0	53.0	35.6	2.58	61.8	20.5	70.6	3.2	6.0	1.7	4.0	44.6	3.12	33.9	4.2	95.4	38.7	4.2	
		9.0	3.4	7.9	53.8	36.0	2.43	62.1	22.2	63.8	2.7	9.0	3.4	7.9	46.5	3.16	35.7	4.3	96.6	42.1	4.4	
60	12.0	5.5	12.7	54.1	36.1	2.36	62.2	22.9	60.4	2.5	12.0	5.5	12.7	47.6	3.18	36.7	4.4	97.3	43.9	4.5		
	60	6.0	1.6	3.7	51.3	34.9	2.86	61.0	17.9	80.3	4.0	6.0	1.6	3.7	49.5	3.22	38.5	4.5	98.5	47.2	4.6	
		9.0	3.2	7.5	52.5	35.4	2.66	61.6	19.7	73.7	3.4	9.0	3.2	7.5	51.8	3.26	40.7	4.7	99.9	51.0	4.8	
70	12.0	5.3	12.2	53.0	35.6	2.57	61.8	20.6	70.3	3.1	12.0	5.3	12.2	53.0	3.29	41.8	4.7	100.7	53.0	4.9		
	70	6.0	1.4	3.3	49.1	34.0	3.21	60.0	15.3	90.0	5.0	6.0	1.4	3.3	54.6	3.32	43.2	4.8	101.6	55.6	5.0	
		9.0	3.0	6.9	50.6	34.7	2.96	60.7	17.1	83.5	4.3	9.0	3.0	6.9	57.2	3.38	45.6	5.0	103.2	59.9	5.3	
80	12.0	4.9	11.3	51.3	34.9	2.85	61.0	18.0	80.2	4.0	12.0	4.9	11.3	58.6	3.41	46.9	5.0	104.1	62.2	5.4		
	80	6.0	1.4	3.3	46.5	33.0	3.62	58.9	12.8	99.6	6.2	6.0	1.4	3.3	59.7	3.44	47.9	5.1	104.7	64.0	5.5	
		9.0	2.9	6.7	48.2	33.7	3.34	59.6	14.4	93.2	5.4	9.0	2.9	6.7	62.5	3.50	50.5	5.2	106.5	68.8	5.8	
90	12.0	4.8	11.1	49.1	34.0	3.21	60.0	15.3	90.0	5.0	10.2	3.6	8.3	63.2	3.52	51.2	5.3	106.9	70.0	5.9		
	90	6.0	1.3	3.1	43.8	31.9	4.11	57.8	10.7	109.3	7.6	5.1	1.1	2.5	63.2	3.52	51.2	5.3	106.9	70.0	5.9	
		9.0	2.8	6.5	45.6	32.6	3.79	58.5	12.0	103.0	6.6	5.1	1.1	2.5	63.2	3.52	51.2	5.3	106.9	70.0	5.9	
100	12.0	4.7	10.9	46.5	33.0	3.63	58.9	12.8	99.8	6.2	5.1	1.1	2.5	63.2	3.52	51.2	5.3	106.9	70.0	5.9		
	100	6.0	1.3	3.0	41.0	30.7	4.67	57.0	8.8	119.0	9.2	3.4	0.6	1.4	63.2	3.52	51.2	5.3	106.9	70.0	5.9	
		9.0	2.7	6.1	42.8	31.5	4.31	57.5	9.9	112.8	8.1	3.4	0.6	1.4	63.2	3.52	51.2	5.3	106.9	70.0	5.9	
110	12.0	4.5	10.4	43.7	31.8	4.13	57.8	10.6	109.6	7.6	3.4	0.6	1.4	63.2	3.52	51.2	5.3	106.9	70.0	5.9		
	110	6.0	1.2	2.8	38.3	29.5	5.32	56.5	7.2	128.8	11.0	2.6	0.4	0.9	63.2	3.52	51.2	5.3	106.9	70.0	5.9	
		9.0	2.6	5.9	40.0	30.3	4.90	56.7	8.2	122.6	9.8	2.6	0.4	0.9	63.2	3.52	51.2	5.3	106.9	70.0	5.9	
120	12.0	4.4	10.1	40.9	30.6	4.70	56.9	8.7	119.5	9.2	2.6	0.4	0.9	63.2	3.52	51.2	5.3	106.9	70.0	5.9		
	120	6.0	1.2	2.8	Operation Not Recommended								2.0	0.2	0.4	63.2	3.52	51.2	5.3	106.9	70.0	5.9
		9.0	2.6	5.9	Operation Not Recommended								2.0	0.2	0.4	63.2	3.52	51.2	5.3	106.9	70.0	5.9
	12.0	4.3	10.0	38.2	29.5	5.36	56.4	7.1	129.4	11.1	2.0	0.2	0.4	63.2	3.52	51.2	5.3	106.9	70.0	5.9		

Interpolation is permissible; extrapolation is not.

All entering air conditions are 80°F DB and 67°F WB in cooling, and 70°F DB in heating.

AHRI/ISO certified conditions are 80.6°F DB and 66.2°F WB in cooling and 68°F DB in heating.

Table does not reflect fan or pump power corrections for AHRI/ISO conditions.

All performance is based upon the lower voltage of dual voltage rated units.

Performance stated is at the rated power supply; performance may vary as the power supply varies from the rated.

Operation below 40°F EWT is based upon a 15% methanol antifreeze solution.

Operation below 60°F EWT requires optional insulated water/refrigerant circuit.

See performance correction tables for operating conditions other than those listed above.

See Performance Data Selection Notes for operation in the shaded areas.

For unit operation in the shaded area when LWT is below 40°F (4.4°C) antifreeze must be used and the JW3 jumper on the DXM2 should be clipped. This is due to the potential of the refrigerant temperature being as low as 32°F (0°C) with 40°F (4.4°C) LWT, which may lead to a nuisance cutout due to the activation of the Low Temperature Protection. JW3

should never be clipped for standard range equipment or systems without antifreeze.

Flow is controlled to maintain minimum LWT 60°F in cooling and maximum LWT 70°F in heating.

Performance Data – HE H/V 060 (Part Load) with Modulating Valve or Variable Speed Pump

1,600 CFM Nominal (Rated) Airflow Cooling, 1,600 CFM Nominal (Rated) Airflow Heating

Performance capacities shown in thousands of Btuh

EWT °F	GPM	WPD		COOLING - EAT 80/67°F							GPM	WPD			HEATING - EAT 70°F						
		PSI	FT	TC	SC	kW	HR	EER	LWT	HWC Cap		PSI	FT	HC	kW	HE	COP	LAT	LWT	HWC Cap	
20	3.0	0.1	0.1	53.7	36.4	1.66	59.3	32.3	60.0	1.5	12.0	6.0	13.8	27.4	2.69	18.2	3.0	86.1	17.0	3.7	
	4.0	0.2	0.5	53.7	36.4	1.66	59.3	32.3	60.0	1.5	6.0	1.2	2.8	30.4	2.72	21.1	3.3	88.1	23.0	3.8	
	4.0	0.2	0.5	53.7	36.4	1.66	59.3	32.3	60.0	1.5	9.0	3.1	7.1	31.5	2.74	22.2	3.4	88.8	25.1	3.8	
30	4.0	0.2	0.5	53.7	36.4	1.66	59.3	32.3	60.0	1.5	12.0	5.4	12.5	32.1	2.74	22.8	3.4	89.2	26.2	3.8	
	5.9	1.0	2.2	53.7	36.4	1.66	59.3	32.3	60.0	1.5	6.0	1.0	2.3	35.0	2.78	25.5	3.7	91.1	31.5	3.9	
	5.9	1.0	2.2	53.7	36.4	1.66	59.3	32.3	60.0	1.5	9.0	2.8	6.4	36.4	2.79	26.8	3.8	92.0	34.0	4.0	
40	5.9	1.0	2.2	53.7	36.4	1.66	59.3	32.3	60.0	1.5	12.0	4.9	11.4	37.1	2.80	27.6	3.9	92.5	35.4	4.0	
	6.0	0.9	2.1	52.1	35.7	1.91	58.6	27.2	69.5	2.0	6.0	0.9	2.1	39.6	2.82	30.0	4.1	94.1	39.9	4.1	
	9.0	2.5	5.9	53.2	36.2	1.74	59.1	30.5	63.1	1.6	9.0	2.5	5.9	41.3	2.84	31.6	4.3	95.3	42.9	4.2	
50	12.0	4.6	10.6	53.7	36.4	1.66	59.3	32.3	60.0	1.5	12.0	4.6	10.6	42.2	2.85	32.5	4.3	95.9	44.5	4.2	
	6.0	0.8	1.9	50.3	35.0	2.18	57.8	23.0	79.3	2.7	6.0	0.8	1.9	44.5	2.88	34.7	4.5	97.4	48.4	4.4	
	9.0	2.4	5.5	51.5	35.5	2.00	58.3	25.7	73.0	2.2	9.0	2.4	5.5	46.5	2.90	36.6	4.7	98.7	51.9	4.5	
60	12.0	4.3	10.0	52.0	35.7	1.92	58.6	27.1	69.8	2.0	12.0	4.3	10.0	47.5	2.91	37.6	4.8	99.4	53.7	4.5	
	6.0	0.8	1.9	48.3	34.3	2.49	56.8	19.4	88.9	3.6	6.0	0.8	1.9	49.4	2.93	39.4	4.9	100.6	56.9	4.7	
	9.0	2.3	5.3	49.6	34.8	2.29	57.4	21.7	82.8	3.0	9.0	2.3	5.3	51.7	2.95	41.6	5.1	102.1	60.8	4.8	
70	12.0	4.2	9.6	50.2	35.0	2.19	57.7	22.9	79.6	2.8	12.0	4.2	9.6	52.9	2.97	42.8	5.2	102.9	62.9	4.9	
	6.0	0.8	1.8	45.9	33.4	2.83	55.6	16.2	98.5	4.8	6.0	0.8	1.8	54.3	2.98	44.1	5.3	103.8	65.3	5.0	
	9.0	2.2	5.1	47.5	34.0	2.61	56.4	18.2	92.5	4.1	9.0	2.2	5.1	56.9	3.01	46.6	5.5	105.5	69.6	5.3	
80	12.0	4.0	9.3	48.2	34.2	2.50	56.7	19.3	89.5	3.7	9.4	2.4	5.6	57.1	3.01	46.8	5.6	105.7	70.0	5.3	
	6.0	0.8	1.7	43.1	32.4	3.23	54.1	13.4	108.0	6.1	4.7	0.3	0.7	57.1	3.01	46.8	5.6	105.7	70.0	5.3	
	9.0	2.2	5.0	44.9	33.1	2.98	55.0	15.1	102.2	5.3	4.7	0.3	0.7	57.1	3.01	46.8	5.6	105.7	70.0	5.3	
90	12.0	3.9	9.1	45.7	33.4	2.86	55.5	16.0	99.2	4.9	4.7	0.3	0.7	57.1	3.01	46.8	5.6	105.7	70.0	5.3	
	6.0	0.7	1.6	39.7	31.1	3.68	52.3	10.8	117.4	7.6	3.1	0.1	0.2	57.1	3.01	46.8	5.6	105.7	70.0	5.3	
	9.0	2.1	4.8	41.8	31.9	3.40	53.4	12.3	111.9	6.7	3.1	0.1	0.2	57.1	3.01	46.8	5.6	105.7	70.0	5.3	
100	12.0	3.9	8.9	42.8	32.3	3.27	53.9	13.1	109.0	6.3	3.1	0.1	0.2	57.1	3.01	46.8	5.6	105.7	70.0	5.3	
	6.0	0.6	1.4	35.7	29.4	4.22	50.1	8.5	126.7	9.3	2.3	0.1	0.2	57.1	3.01	46.8	5.6	105.7	70.0	5.3	
	9.0	2.0	4.6	38.1	30.5	3.90	51.4	9.8	121.4	8.3	2.3	0.1	0.2	57.1	3.01	46.8	5.6	105.7	70.0	5.3	
110	12.0	3.8	8.7	39.2	30.9	3.75	52.0	10.5	118.7	7.8	2.3	0.1	0.2	57.1	3.01	46.8	5.6	105.7	70.0	5.3	
	6.0	0.4	1.0	31.0	27.1	4.83	47.5	6.4	135.8	11.3	1.9	0.1	0.2	57.1	3.01	46.8	5.6	105.7	70.0	5.3	
	9.0	1.9	4.3	33.7	28.5	4.48	49.0	7.5	130.9	10.2	1.9	0.1	0.2	57.1	3.01	46.8	5.6	105.7	70.0	5.3	
120	12.0	3.7	8.4	35.0	29.1	4.31	49.7	8.1	128.3	9.6	1.9	0.1	0.2	57.1	3.01	46.8	5.6	105.7	70.0	5.3	

Interpolation is permissible; extrapolation is not.
 All entering air conditions are 80°F DB and 67°F WB in cooling, and 70°F DB in heating.
 AHR/ISO certified conditions are 80.6°F DB and 66.2°F WB in cooling and 68°F DB in heating.
 Table does not reflect fan or pump power corrections for AHR/ISO conditions.
 All performance is based upon the lower voltage of dual voltage rated units.
 Performance stated is at the rated power supply; performance may vary as the power supply varies from the rated.
 Operation below 40°F EWT is based upon a 15% methanol antifreeze solution.
 Operation below 60°F EWT requires optional insulated water/refrigerant circuit.
 See performance correction tables for operating conditions other than those listed above.
 See Performance Data Selection Notes for operation in the shaded areas.
 For unit operation in the shaded area when LWT is below 40°F (4.4°C) antifreeze must be used and the JW3 jumper on the DXM2 should be clipped. This is due to the potential of the refrigerant temperature being as low as 32°F (0°C) with 40°F (4.4°C) LWT, which may lead to a nuisance cutout due to the activation of the Low Temperature Protection. JW3 should never be clipped for standard range equipment or systems without antifreeze.
 Flow is controlled to maintain minimum LWT 60°F in cooling and maximum LWT 70°F in heating.

Performance Data – HE H/V 060 (Full Load) with Modulating Valve or Variable Speed Pump

1,900 CFM Nominal (Rated) Airflow Cooling, 1,900 CFM Nominal (Rated) Airflow Heating

Performance capacities shown in thousands of Btuh

EWT °F	GPM	WPD		COOLING - EAT 80/67°F							GPM	WPD		HEATING - EAT 70°F						
		PSI	FT	TC	SC	kW	HR	EER	LWT	HWC Cap		PSI	FT	HC	kW	HE	COP	LAT	LWT	HWC Cap
20	4.1	0.5	1.1	72.0	47.3	2.89	81.9	24.9	60.0	2.5	14.0	7.9	18.2	39.9	3.66	27.5	3.2	87.4	16.1	4.5
	5.5	0.9	2.2	72.0	47.3	2.89	81.9	24.9	60.0	2.5	7.0	1.8	4.1	43.0	3.72	30.4	3.4	88.9	21.3	4.7
30	5.5	0.9	2.2	72.0	47.3	2.89	81.9	24.9	60.0	2.5	10.5	4.2	9.7	44.7	3.75	31.9	3.5	89.7	23.9	4.8
	5.5	0.9	2.2	72.0	47.3	2.89	81.9	24.9	60.0	2.5	14.0	7.2	16.5	45.6	3.77	32.7	3.5	90.2	25.3	4.8
40	7.0	1.6	3.6	71.4	47.0	2.98	81.5	23.9	63.3	2.6	7.0	1.5	3.6	48.6	3.84	35.5	3.7	91.6	29.8	5.0
	8.2	2.3	5.2	72.0	47.3	2.89	81.9	24.9	60.0	2.5	10.5	3.8	8.8	50.7	3.88	37.5	3.8	92.7	32.9	5.2
	8.2	2.3	5.2	72.0	47.3	2.89	81.9	24.9	60.0	2.5	14.0	6.6	15.2	51.9	3.91	38.6	3.9	93.2	34.5	5.2
50	7.0	1.4	3.2	69.5	46.3	3.26	80.6	21.3	73.0	3.3	7.0	1.4	3.2	54.7	3.97	41.1	4.0	94.6	38.3	5.4
	10.5	3.5	8.1	70.9	46.8	3.05	81.3	23.3	65.5	2.8	10.5	3.5	8.1	57.3	4.04	43.5	4.2	95.8	41.7	5.6
	14.0	6.2	14.2	71.7	47.1	2.94	81.7	24.4	61.7	2.6	14.0	6.2	14.3	58.7	4.07	44.8	4.2	96.5	43.6	5.7
60	7.0	1.3	3.0	67.5	45.5	3.56	79.6	19.0	82.7	4.1	7.0	1.3	3.0	61.0	4.13	46.9	4.3	97.7	46.6	5.9
	10.5	3.3	7.6	69.0	46.1	3.33	80.4	20.7	75.3	3.5	10.5	3.3	7.6	64.0	4.20	49.7	4.5	99.1	50.5	6.1
	14.0	5.9	13.5	69.8	46.4	3.22	80.7	21.7	71.5	3.2	14.0	5.8	13.5	65.7	4.25	51.2	4.5	99.9	52.7	6.3
70	7.0	1.2	2.9	65.2	44.6	3.89	78.5	16.7	92.4	5.2	7.0	1.2	2.9	67.4	4.29	52.8	4.6	100.8	54.9	6.4
	10.5	3.2	7.3	67.0	45.3	3.63	79.4	18.4	85.1	4.4	10.5	3.2	7.3	70.8	4.38	55.9	4.7	102.4	59.4	6.7
	14.0	5.6	13.0	67.8	45.6	3.51	79.8	19.3	81.4	4.1	14.0	5.6	13.0	72.7	4.43	57.6	4.8	103.3	61.8	6.9
80	7.0	1.2	2.8	62.6	43.6	4.29	77.2	14.6	102.1	6.4	7.0	1.2	2.8	73.8	4.46	58.6	4.8	103.9	63.3	7.0
	10.5	3.1	7.1	64.6	44.4	3.99	78.2	16.2	94.9	5.5	10.5	3.1	7.1	77.5	4.57	61.9	5.0	105.7	68.2	7.4
	14.0	5.4	12.6	65.5	44.7	3.85	78.6	17.0	91.2	5.1	14.0	5.4	12.6	78.8	4.60	63.1	5.0	106.3	70.0	7.5
90	7.0	1.2	2.7	59.4	42.4	4.77	75.6	12.4	111.6	7.8	6.3	0.9	2.0	78.8	4.60	63.1	5.0	106.3	70.0	7.5
	10.5	3.0	6.9	61.8	43.3	4.41	76.8	14.0	104.6	6.8	6.3	0.9	2.0	78.8	4.60	63.1	5.0	106.3	70.0	7.5
	14.0	5.3	12.3	62.9	43.7	4.25	77.4	14.8	101.0	6.3	6.3	0.9	2.0	78.8	4.60	63.1	5.0	106.3	70.0	7.5
100	7.0	1.1	2.6	55.5	40.9	5.35	73.8	10.4	121.1	9.4	4.2	0.1	0.1	78.8	4.60	63.1	5.0	106.3	70.0	7.5
	10.5	2.9	6.8	58.3	42.0	4.92	75.1	11.8	114.3	8.3	4.2	0.1	0.1	78.8	4.60	63.1	5.0	106.3	70.0	7.5
	14.0	5.2	12.1	59.7	42.5	4.73	75.8	12.6	110.8	7.7	4.2	0.1	0.1	78.8	4.60	63.1	5.0	106.3	70.0	7.5
110	7.0	1.0	2.4	50.9	39.0	6.04	71.5	8.4	130.4	11.2	3.2	0.1	0.1	78.8	4.60	63.1	5.0	106.3	70.0	7.5
	10.5	2.8	6.6	54.2	40.4	5.55	73.1	9.8	123.9	10.0	3.2	0.1	0.1	78.8	4.60	63.1	5.0	106.3	70.0	7.5
	14.0	5.1	11.9	55.8	41.0	5.31	73.9	10.5	120.6	9.4	3.2	0.1	0.1	78.8	4.60	63.1	5.0	106.3	70.0	7.5
120	7.0	0.9	2.0	45.4	36.5	6.86	68.8	6.6	139.7	13.2	2.5	0.1	0.1	78.8	4.60	63.1	5.0	106.3	70.0	7.5
	10.5	2.7	6.3	49.2	38.3	6.29	70.7	7.8	133.5	11.9	2.5	0.1	0.1	78.8	4.60	63.1	5.0	106.3	70.0	7.5
	14.0	5.0	11.6	51.0	39.1	6.02	71.6	8.5	130.2	11.2	2.5	0.1	0.1	78.8	4.60	63.1	5.0	106.3	70.0	7.5

Interpolation is permissible; extrapolation is not.

All entering air conditions are 80°F DB and 67°F WB in cooling, and 70°F DB in heating.

AHRI/ISO certified conditions are 80.6°F DB and 66.2°F WB in cooling and 68°F DB in heating.

Table does not reflect fan or pump power corrections for AHRI/ISO conditions.

All performance is based upon the lower voltage of dual voltage rated units.

Performance stated is at the rated power supply; performance may vary as the power supply varies from the rated.

Operation below 40°F EWT is based upon a 15% methanol antifreeze solution.

Operation below 60°F EWT requires optional insulated water/refrigerant circuit.

See performance correction tables for operating conditions other than those listed above.

See Performance Data Selection Notes for operation in the shaded areas.

For unit operation in the shaded area when LWT is below 40°F (4.4°C) antifreeze must be used and the JW3 jumper on the DXM2 should be clipped. This is due to the potential of the refrigerant temperature being as low as 32°F (0°C) with 40°F (4.4°C) LWT, which may lead to a nuisance cutout due to the activation of the Low Temperature Protection. JW3 should never be clipped for standard range equipment or systems without antifreeze.

Flow is controlled to maintain minimum LWT 60°F in cooling and maximum LWT 70°F in heating.

Part Load Performance Data – Correction Tables

Airflow Correction Table

Airflow	Heating			Cooling				
	% of Rated	Heating Capacity	Power	Heat of Extraction	Total Capacity	Sensible Capacity	S/T	Power
80	0.979	1.035	0.965	0.980	0.917	0.936	0.955	0.975
85	0.984	1.021	0.975	0.986	0.939	0.953	0.964	0.982
90	0.990	1.011	0.984	0.992	0.961	0.969	0.975	0.988
95	0.995	1.004	0.993	0.996	0.981	0.985	0.986	0.994
100	1.000	1.000	1.000	1.000	1.000	1.000	1.000	1.000
105	1.006	1.002	1.007	1.003	1.017	1.014	1.016	1.005
110	1.011	1.006	1.012	1.004	1.031	1.027	1.033	1.010

Entering Air Correction Table

EAT Heating Corrections			
Ent Air DB °F	Heating Capacity	Power	Heat of Extraction
50	1.023	0.773	1.084
55	1.021	0.827	1.068
60	1.016	0.882	1.049
65	1.009	0.940	1.026
70	1.000	1.000	1.000
75	0.989	1.063	0.971
80	0.978	1.128	0.941

* = Sensible capacity equals total capacity
 AHR/ISO/ASHRAE 13256-1 uses entering air conditions of Cooling - 80.6°F DB/66.2°F WB, 1 and Heating - 68°F DB/59°F WB entering air temperature

Cooling											
Ent Air WB °F	Total Capacity	Sensible Cooling Capacity Multipliers - Entering DB °F								Power	Heat of Rejection
		65	70	75	80	85	90	95	100		
45	0.628	*	*	*	*	*	*	*	*	1.010	0.698
50	0.712	*	*	*	*	*	*	*	*	1.008	0.767
55	0.797	1.026	*		*	*	*	*	*	1.006	0.835
60	0.882	0.669	0.894	1.111	*	*	*	*	*	1.003	0.904
65	0.966		0.693	0.890	1.092	1.298	*	*	*	1.001	0.973
67	1.000		0.640	0.810	1.000	1.202	*	*	*	1.000	1.000
70	1.051			0.706	0.862	1.060	1.298	*	*	0.999	1.041
75	1.135				0.633	0.860	1.087	1.314	1.541	0.996	1.110

Full Load Performance Data – Correction Tables

Airflow Correction Table

Airflow	Heating			Cooling				
	% of Rated	Heating Capacity	Power	Heat of Extraction	Total Capacity	Sensible Capacity	S/T	Power
80	0.983	1.040	0.967	0.976	0.919	0.941	0.939	0.969
85	0.987	1.018	0.978	0.984	0.941	0.957	0.953	0.977
90	0.991	1.004	0.988	0.990	0.962	0.972	0.968	0.986
95	0.996	0.998	0.995	0.996	0.982	0.986	0.983	0.993
100	1.000	1.000	1.000	1.000	1.000	1.000	1.000	1.000
105	1.005	1.010	1.003	1.003	1.017	1.014	1.018	1.006
110	1.009	1.028	1.004	1.005	1.032	1.027	1.036	1.012

Entering Air Correction Table

EAT Heating Corrections			
Ent Air DB °F	Heating Capacity	Power	Heat of Extraction
50	1.030	0.808	1.092
55	1.026	0.858	1.073
60	1.020	0.905	1.052
65	1.011	0.951	1.027
70	1.000	1.000	1.000
75	0.989	1.054	0.971
80	0.978	1.114	0.940

* = Sensible capacity equals total capacity
 AHRI/ISO/ASHRAE 13256-1 uses entering air conditions of Cooling - 80.6°F DB/66.2°F WB, 1 and Heating - 68°F DB/59°F WB entering air temperature

Cooling											
Ent Air WB °F	Total Capacity	Sensible Cooling Capacity Multipliers - Entering DB °F								Power	Heat of Rejection
		65	70	75	80	85	90	95	100		
45	0.638	*	*	*	*	*	*	*	*	0.914	0.694
50	0.720	*	*	*	*	*	*	*	*	0.934	0.763
55	0.803	1.044	*	*	*	*	*	*	*	0.953	0.833
60	0.885	0.751	0.927	1.114	*	*	*	*	*	0.973	0.903
65	0.967		0.693	0.886	1.089	1.300	*	*	*	0.992	0.972
67	1.000		0.607	0.798	1.000	1.211	1.432	*	*	1.000	1.000
70	1.049			0.669	0.866	1.076	1.299	*	*	1.012	1.042
75	1.132				0.644	0.848	1.077	1.329	1.605	1.031	1.111

High Head and Standard Variable Pump Performance

Standard Head Variable Pump Performance

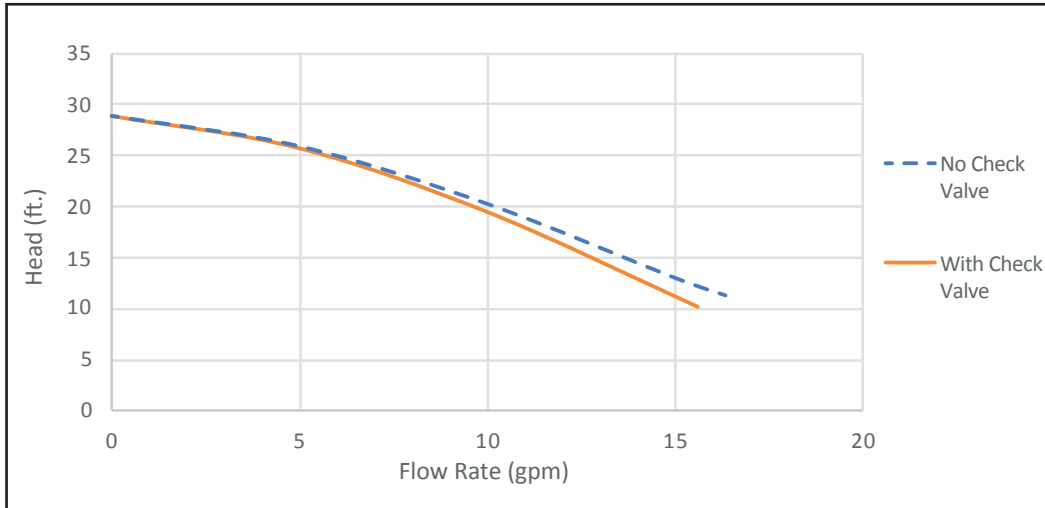

High Head Variable Pump Performance

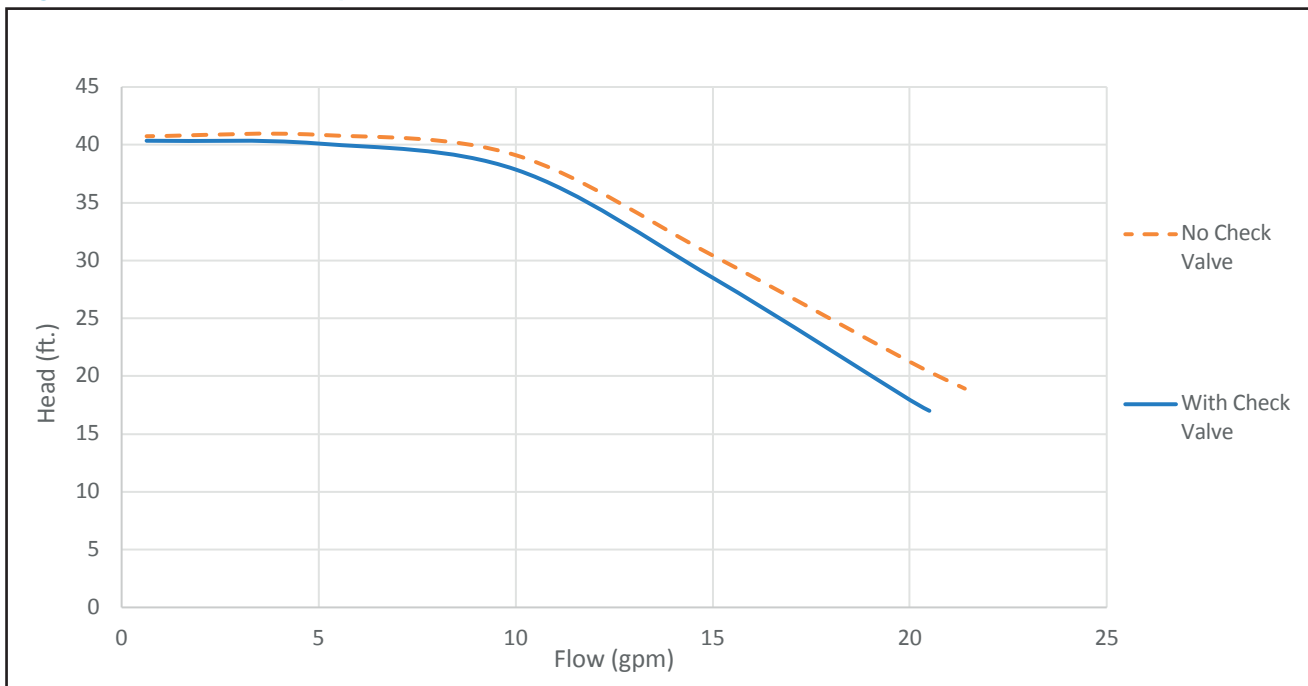

Antifreeze Correction Table

EWT	Antifreeze Type	Antifreeze %	Cooling			Heating		WPD
			Total Cap	Sensible Cap	Watts	Total Cap	Watts	
90	Water	0%	1	1	1	1	1	1
	Ethanol	5%	0.998	0.998	1.002	0.996	0.999	1.025
		10%	0.996	0.996	1.003	0.991	0.997	1.048
		15%	0.994	0.994	1.005	0.987	0.996	1.098
		20%	0.991	0.991	1.006	0.982	0.994	1.142
		25%	0.986	0.986	1.009	0.972	0.991	1.207
		30%	0.981	0.981	1.012	0.962	0.988	1.265
		35%	0.977	0.977	1.015	0.953	0.985	1.312
		40%	0.972	0.972	1.018	0.943	0.982	1.37
		45%	0.966	0.966	1.023	0.931	0.978	1.431
	50%	0.959	0.959	1.027	0.918	0.974	1.494	
	Ethylene Glycol	5%	0.998	0.998	1.002	0.996	0.999	1.021
		10%	0.996	0.996	1.003	0.991	0.997	1.04
		15%	0.994	0.994	1.004	0.987	0.996	1.079
		20%	0.991	0.991	1.005	0.982	0.995	1.114
		25%	0.988	0.988	1.008	0.976	0.993	1.146
		30%	0.985	0.985	1.01	0.969	0.99	1.175
		35%	0.982	0.982	1.012	0.963	0.988	1.208
		40%	0.979	0.979	1.014	0.956	0.986	1.243
		45%	0.976	0.976	1.016	0.95	0.984	1.278
	50%	0.972	0.972	1.018	0.943	0.982	1.314	
	Methanol	5%	0.997	0.997	1.002	0.993	0.998	1.039
		10%	0.993	0.993	1.004	0.986	0.996	1.075
		15%	0.99	0.99	1.007	0.979	0.994	1.116
		20%	0.986	0.986	1.009	0.972	0.991	1.154
		25%	0.982	0.982	1.012	0.964	0.989	1.189
		30%	0.978	0.978	1.014	0.955	0.986	1.221
		35%	0.974	0.974	1.017	0.947	0.984	1.267
		40%	0.97	0.97	1.02	0.939	0.981	1.31
		45%	0.966	0.966	1.023	0.93	0.978	1.353
	50%	0.961	0.961	1.026	0.92	0.975	1.398	
	Propylene Glycol	5%	0.995	0.995	1.003	0.99	0.997	1.065
		10%	0.99	0.99	1.006	0.98	0.994	1.119
		15%	0.986	0.986	1.009	0.971	0.991	1.152
		20%	0.981	0.981	1.012	0.962	0.988	1.182
		25%	0.978	0.978	1.014	0.956	0.986	1.227
		30%	0.975	0.975	1.016	0.95	0.984	1.267
		35%	0.972	0.972	1.018	0.944	0.982	1.312
		40%	0.969	0.969	1.02	0.938	0.98	1.356
		45%	0.965	0.965	1.023	0.929	0.977	1.402
	50%	0.96	0.96	1.026	0.919	0.974	1.45	

Table Continued on Next Page

Antifreeze Correction Table, Cont'd.

Table Continued from Previous Page

EWT	Antifreeze Type	Antifreeze %	Cooling			Heating		WPD
			Total Cap	Sensible Cap	Watts	Total Cap	Watts	
30	Water	0%	1	1	1	1	1	1
	Ethanol	5%	0.991	0.991	1.006	0.981	0.994	1.14
		10%	0.981	0.981	1.012	0.961	0.988	1.242
		15%	0.973	0.973	1.018	0.944	0.983	1.295
		20%	0.964	0.964	1.024	0.927	0.977	1.343
		25%	0.959	0.959	1.028	0.917	0.974	1.363
		30%	0.954	0.954	1.031	0.907	0.97	1.383
		35%	0.949	0.949	1.035	0.897	0.967	1.468
		40%	0.944	0.944	1.038	0.887	0.964	1.523
		45%	0.94	0.94	1.041	0.88	0.962	1.58
	50%	0.936	0.936	1.043	0.872	0.959	1.639	
	Ethylene Glycol	5%	0.997	0.997	1.002	0.993	0.998	1.04
		10%	0.993	0.993	1.004	0.986	0.996	1.075
		15%	0.99	0.99	1.006	0.98	0.994	1.122
		20%	0.987	0.987	1.008	0.973	0.992	1.163
		25%	0.983	0.983	1.011	0.966	0.99	1.195
		30%	0.979	0.979	1.013	0.958	0.987	1.225
		35%	0.976	0.976	1.016	0.951	0.985	1.279
		40%	0.972	0.972	1.018	0.943	0.982	1.324
		45%	0.969	0.969	1.021	0.937	0.98	1.371
	50%	0.966	0.966	1.023	0.93	0.978	1.419	
	Methanol	5%	0.995	0.995	1.004	0.989	0.997	1.069
		10%	0.989	0.989	1.007	0.978	0.993	1.127
		15%	0.984	0.984	1.011	0.968	0.99	1.164
		20%	0.979	0.979	1.014	0.957	0.986	1.197
		25%	0.975	0.975	1.017	0.949	0.984	1.216
		30%	0.971	0.971	1.019	0.941	0.981	1.235
		35%	0.967	0.967	1.022	0.933	0.979	1.286
		40%	0.963	0.963	1.025	0.924	0.976	1.323
		45%	0.959	0.959	1.028	0.917	0.974	1.36
	50%	0.955	0.955	1.03	0.91	0.971	1.399	
	Propylene Glycol	5%	0.995	0.995	1.004	0.989	0.997	1.071
		10%	0.989	0.989	1.007	0.978	0.993	1.13
		15%	0.985	0.985	1.01	0.968	0.99	1.206
		20%	0.98	0.98	1.013	0.958	0.987	1.27
		25%	0.974	0.974	1.017	0.947	0.983	1.359
		30%	0.968	0.968	1.021	0.935	0.979	1.433
		35%	0.963	0.963	1.025	0.924	0.976	1.522
		40%	0.957	0.957	1.029	0.913	0.972	1.614
		45%	0.949	0.949	1.034	0.898	0.967	1.712
	50%	0.941	0.941	1.039	0.882	0.962	1.816	

Water Pressure Drop Adder for Options – Correction Tables

Modulating Water Valve Corrections

High System Pressure Drop Valve

Model	CV	MOPD	WPD Adders		
			GPM	PSI	FT
024	4.7	200	3.0	0.41	0.94
	4.7	200	4.5	0.92	2.12
	4.7	200	6.0	1.63	3.76
030	4.7	200	3.8	0.65	1.51
	4.7	200	5.6	1.42	3.28
	4.7	200	7.5	2.55	5.88
036	4.7	200	4.5	0.92	2.12
	4.7	200	6.8	2.09	4.84
	4.7	200	9.0	3.67	8.47
042	4.7	200	5.3	1.27	2.94
	4.7	200	7.9	2.83	6.53
	4.7	200	10.5	4.99	11.53
048	4.7	200	6.0	1.63	3.76
	4.7	200	9.0	3.67	8.47
	4.7	200	12.0	6.52	15.06
060	7.4	200	7.0	.89	2.06
	7.4	200	10.5	2.01	4.64
	7.4	200	14.0	3.58	8.26

Low System Pressure Drop Valve

Model	CV	MOPD	WPD Adders		
			GPM	PSI	FT
024	4.7	200	3.0	0.41	0.94
	4.7	200	4.5	0.92	2.12
	4.7	200	6.0	1.63	3.76
030	7.4	200	3.8	0.26	0.61
	7.4	200	5.6	0.57	1.32
	7.4	200	7.5	1.03	2.37
036	7.4	200	4.5	0.37	0.85
	7.4	200	6.8	0.84	1.95
	7.4	200	9.0	1.48	3.42
042	10.0	200	5.3	0.28	0.65
	10.0	200	7.9	0.62	1.44
	10.0	200	10.5	1.10	2.55
048	10.0	200	6.0	0.36	0.83
	10.0	200	9.0	0.81	1.87
	10.0	200	12.0	1.44	3.33
060	19.0	200	7.0	0.14	0.31
	19.0	200	10.5	0.31	0.70
	19.0	200	14.0	0.54	1.25

ECM Blower Control

The ECM fan is controlled directly by the DXM2 control board. It converts thermostat inputs and CFM settings to signals used by the ECM motor controller. To take full advantage of the ECM motor features, a communicating multi-stage thermostat should be used (7602-457**).

The DXM2 control maintains a selectable operating airflow [CFM] for each heat pump operating mode. For each operating mode there are maximum and minimum airflow limits. See the ECM Blower Performance tables for the maximum, minimum, and default operating airflows.

Airflow levels are selected using the configuration menus of a communicating thermostat (7602-457**) or configuration/diagnostic tool (7602-444*). The configuration menus allow the installer to independently select and adjust the operating airflow for each of the operating modes. Airflow can be selected in 25 CFM increments within the minimum and maximum limits shown in the ECM Blower Performance Table. The blower operating modes include:

- First Stage Cooling (Y1 & O)
- Second Stage Cooling (Y1, Y2, & O)
- First Stage Cooling in Dehumidification Mode (Y1, O, & Dehumid)
- Second Stage Cooling in Dehumidification Mode (Y1, Y2, O, & Dehumid)
- First Stage Heating (Y1)
- Second Stage Heating (Y1 & Y2)
- Third Stage (Auxiliary) Heating (Y1, Y2, & W)
- Emergency Heating (W with no Y1 or Y2)
- Fan (G with no Y1, Y2, or W)

It is necessary to use the 7602-457** communicating thermostat to engage the Auto Dehumidification feature on units with variable speed pumps. These units utilize the 'H' terminal on the DXM2 as an input for an ambient temperature switch. Units without the variable speed pump option may use the 'H' terminal on the DXM2 controller or the 7602-457** communicating thermostat to initiate the Auto Dehumidification mode. Refer to the DXM2 AOM for more information (part #97B0003N15).

The ECM motor includes "soft start" and "ramp down" features. The soft start feature is a gentle increase of motor rpm at blower start up. This creates a much quieter blower start cycle.

The ramp down feature allows the blower to slowly decrease rpm to a full stop at the end of each blower cycle. This creates a much quieter end to each blower cycle and adds overall unit efficiency.

The ramp down feature is eliminated during an ESD (Emergency Shut Down) situation. When the DXM2 ESD input is activated, the blower and all other control outputs are immediately de-activated.

The ramp down feature (also known as the heating or cooling "Off Delay") is field selectable by the installer. The allowable range is 0 to 255 seconds.

Airflow Configuration Screen on Communicating Thermostat

AIRFLOW SELECTION	
	CFM
HEAT STAGE 1	600
HEAT STAGE 2	750
AUXILIARY HEAT	850
EMERGENCY HEAT	850
COOL STAGE 1	525
COOL STAGE 2	700
COOL DEHUMID 1	425
COOL DEHUMID 2	550
CONTINUOUS FAN	350
HEAT OFF DELAY	60
COOL OFF DELAY	30
◀ PREVIOUS	NEXT ▶

Blower Performance Data

Model	Max ESP (in wg)	Fan Motor (hp)	Range	Cooling Mode		Dehumid Mode		Heating Mode		Fan Only Mode	Aux Emerg Mode
				Stg 2	Stg 1	Stg 2	Stg 1	Stg 2	Stg 1		
024	0.75	1/2	Default	750	575	650	500	750	575	350	750
			Maximum	850	650	800	600	850	850	850	850
			Minimum	600	450	600	450	600	450	300	650
030	0.5	1/2	Default	950	650	800	575	950	650	450	950
			Maximum	1100	750	1000	700	1100	1100	1100	1100
			Minimum	750	525	750	525	750	525	375	750
036	0.6	1/2	Default	1125	750	975	650	1125	750	525	1125
			Maximum	1250	950	1200	800	1250	1250	1250	1250
			Minimum	900	600	900	600	900	600	450	900
042	0.6	3/4	Default	1300	925	1125	825	1300	925	600	1300
			Maximum	1475	1100	1400	1000	1475	1475	1475	1475
			Minimum	1050	750	1050	750	1050	750	525	1050
048	0.75	3/4	Default	1500	1125	1300	975	1500	1125	700	1500
			Maximum	1700	1300	1600	1200	1700	1700	1700	1700
			Minimum	1200	900	1200	900	1200	900	600	1350
060	0.75	1	Default	1875	1500	1625	1300	1875	1500	875	1875
			Maximum	2100	1700	2000	1600	2100	2100	2100	2100
			Minimum	1500	1200	1500	1200	1500	1200	750	1500

Airflow is controlled within 5% up to the Max ESP shown with wet coil.
Performance shown is with wet coil and factory air filters.

Model	024	030	036	042	048	060
Compressor (1 Each)	Scroll					
Factory Charge HFC-410A (oz)	51	48	54	70	80	80
ECM Fan Motor & Blower						
Fan Motor (hp)	1/2	1/2	1/2	3/4	3/4	1
Blower Wheel Size (dia x w) - (in)	9X7	9X7	9X8	9X8	10X10	11X10
Water Connection Size						
FPT(in)	3/4"	3/4"	3/4"	3/4"	1"	1"
Coax Volume (gallons)	0.323	0.323	0.738	0.89	0.738	0.939
HWG Connection Size						
FPT(in)	1/2"					
Vertical Upflow						
Air Coil Dimensions (h x w) - (in)	20 X 17.25	20 X 17.25	24 X 21.75	24 X 21.75	28.75 X 24	28.75 X 24
Standard Filter - 1" [25.4mm] Throwaway, qty (in)	20x20	20x20	24x24	24x24	28x28	28x28
Weight - Operating, (lbs)	216	224	249	260	315	330
Weight - Packaged, (lbs)	221	229	255	266	322	337
Horizontal						
Air Coil Dimensions (h x w) - (in)	16 X 22	16 X 22	20 X 25	20 X 25	20 X 35	20 X 35
Standard Filter - 1" [25.4mm] Throwaway, qty (in)	18x25	18x25	20x28 or 2-20x14	20x28 or 2-20x14	1-20x24, 1-20x14	1-20x24, 1-20x14
Weight - Operating, (lbs)	208	208	233	244	299	314
Weight - Packaged, (lbs)	213	213	239	250	306	321

Notes:

All units have TXV expansion device and 1/2" & 3/4" electrical knockouts.

Unit Maximum Water Working Pressure	
Options	Max Pressure PSIG [kPa]
Internal Pump	145 [999]
Internal Modulating Water Valve (MWV)	300 [2,068]

HE – Horizontal Dimensional Data

Horizontal Model		Overall Cabinet		
		A Width	B Length	C Height
024 - 030	in	22.4	48.3	18.3
	cm	56.9	122.7	46.5
036 - 042	in	22.4	53.1	21.0
	cm	56.9	134.9	53.3
048 - 060	in	25.4	68.0	21.0
	cm	64.5	172.7	53.3

Horizontal Model		Water Connections										
		①		②		③		④		⑤		Loop In/Out FPT
		Loop In D	Loop In E	Loop Out F	Loop Out E	AA	BB	HWG In 1/2" FPT		HWG Out 1/2" FPT		
								DD	EE	FF	EE	
024 - 030	in	3.7	1.4	9.7	1.4	3.3	0.7	12.4	1.4	15.7	1.4	3/4"
	cm	9.4	3.6	24.6	3.6	8.4	1.8	31.5	3.6	39.9	3.6	
036 - 042	in	3.7	1.4	12.7	1.4	3.3	0.7	15.2	1.4	18.4	1.4	3/4"
	cm	9.4	3.6	32.3	3.6	8.4	1.8	38.6	3.6	46.7	3.6	
048 - 060	in	3.7	1.4	12.7	1.4	3.3	0.7	15.2	1.4	18.4	1.4	1"
	cm	9.4	3.6	32.3	3.6	8.4	1.8	38.6	3.6	46.7	3.6	

Horizontal Model		Electrical Knockouts	
		J 1/2"	K 3/4"
		Low Voltage	Power Supply
024-060	in	7.0	10.0
	cm	18.8	25.4

Notes:

1. While clear access to all removable panels is not required, installer should take care to comply with all building codes and allow adequate clearance for future field service.
2. Horizontal units shipped with filter bracket only. This bracket should be removed for return duct connection.
3. Discharge flange and hanger brackets are factory installed.
4. Condensate is rubber coupling that couples to 3/4" schedule 40/80 PVC.
5. Blower service panel requires 2' service access.
6. Blower service access is through back panel on straight discharge units or through panel opposite air coil on back discharge units.
7. Water connections for optional hot water generator are 1/2" FPT.

Legend:

- CAP = Control Access Panel
 BSP = Blower Service Panel
 CSP = Compressor Access Panel
 ASP = Alternative Service Panel (Optional Access, Not Required)

HE – Horizontal Dimensional Data

Horizontal Model		Discharge Connection Duct Flange Installed (+/- 0.10 in, +/- 2.5mm)					Return Connection Using Return Air Opening			
		L	M Supply Height	N Supply Width	O	P	Q Return Width	R Return Height	S	T
024 - 030	in	1.2	13.1	9.7	3.9	4.0	22.9	16.3	0.8	1.0
	cm	3.0	33.3	24.6	9.9	10.2	58.2	41.4	2.0	2.5
036 - 042	in	2.4	16.1	11.0	2.9	2.7	26.1	19.0	1.1	1.0
	cm	6.1	40.9	27.9	7.4	6.9	66.3	48.3	2.8	2.5
048 - 060	in	1.2	16.1	13.6	4.0	4.0	35.0	19.0	1.1	1.0
	cm	3.0	40.9	34.5	10.2	10.2	88.9	48.3	2.8	2.5

All dimensions are +/- 0.20 in, (+/-5.1 mm).

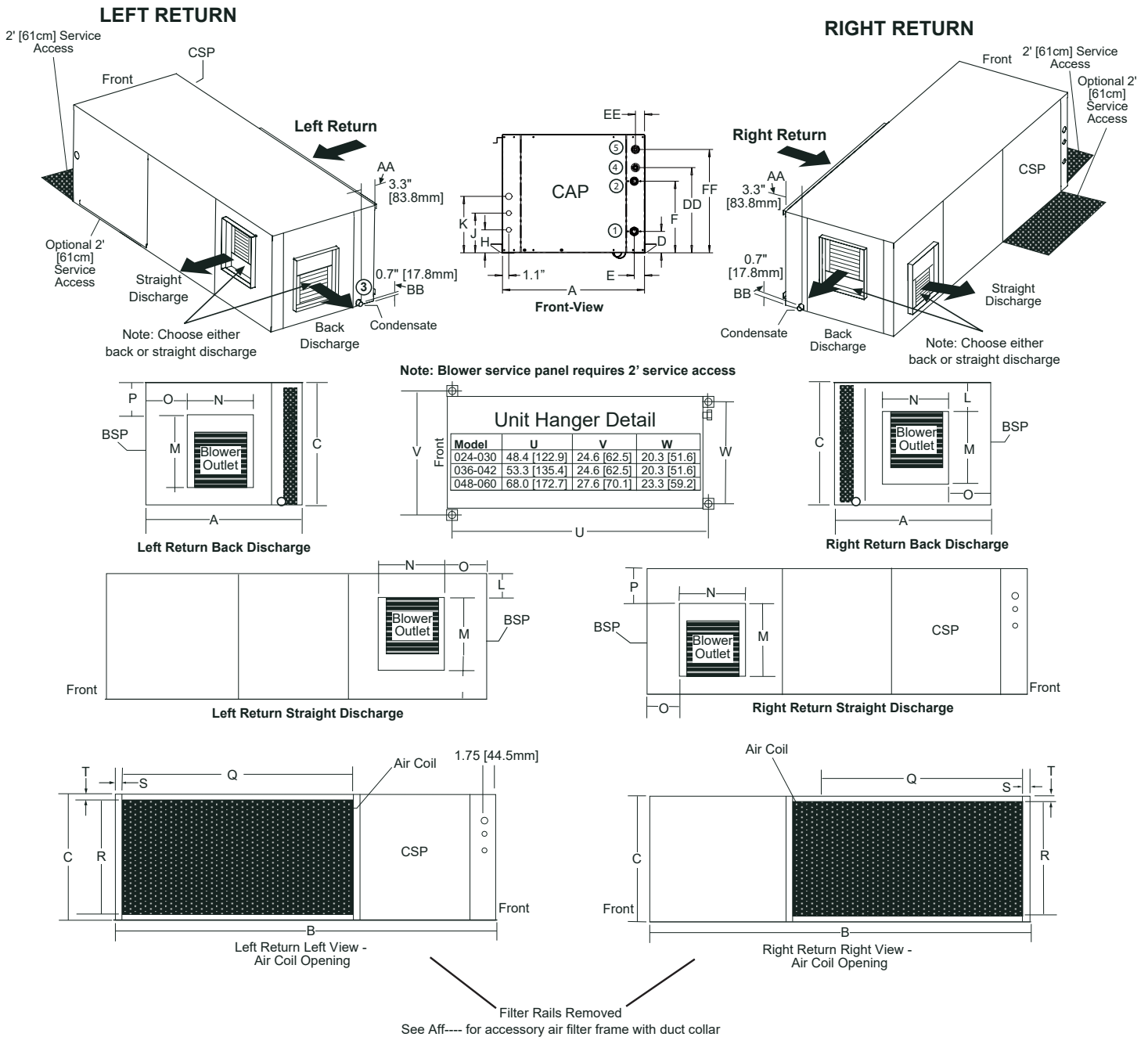

HE – Vertical Upflow Dimensional Data

Vertical Upflow Model		Overall Cabinet		
		A Width	B Depth	C Height
024 - 030	in cm	22.4 56.9	22.4 56.9	40.0 101.6
036 - 042	in cm	22.4 56.9	25.4 64.5	45.0 114.3
048 - 060	in cm	25.4 64.5	29.1 73.9	50.5 128.3

Vertical Model		Electrical Knockouts	
		K 1/2"	L 3/4"
024 - 060	in cm	Low Voltage	Power Supply
		7.0 17.8	10.0 25.4

Vertical Upflow Model		Water Connections - Standard Units										
		1		2		3		4		5		Loop In/ Out FPT
		Loop In D	Loop In E	Loop Out F	Loop Out E	H	I	HWG In 1/2" FPT		HWG In 1/2" FPT		
								DD	EE	FF	EE	
024 - 030	in cm	3.7 9.4	1.4 3.6	9.7 24.6	1.4 3.6	19.7 50.0	1.4 3.6	13.2 33.5	1.4 3.6	15.7 39.9	1.4 3.6	3/4"
036 - 042	in cm	3.8 9.7	1.4 3.6	9.8 24.9	1.4 3.6	20.6 52.3	1.4 3.6	13.5 34.3	1.4 3.6	16.0 40.6	1.4 3.6	3/4"
048 - 060	in cm	3.7 9.4	1.4 3.6	9.8 24.9	1.4 3.6	22.1 56.1	1.4 3.6	16.0 40.6	1.4 3.6	18.5 47.0	1.4 3.6	1"

Recommended Minimum Installation Clearances for Vertical Units*	
1"	Back of unit
	Side opposite return air
6"	Front if hard piped
Return Air Side	
1"	Ducted return
	- ‡ *Add for duct width - † Add 2" for 1" filter frame/rail or 3" for 2" filter frame/rail
	Free (open) return - calculate required dimension for a maximum velocity of 600 fpm

*Field installed accessories (hoses, air cleaners, etc.) and factory WSE option will require additional space. Top supply air is shown, the same clearances apply to bottom supply air units.

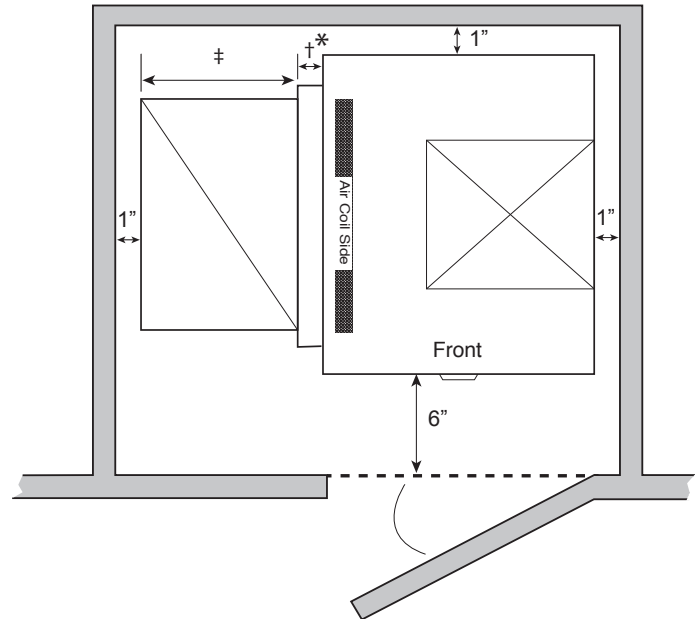

Notes:

- While clear access to all removable panels is not required, installer should take care to comply with all building codes and allow adequate clearance for future field service.
- Front & Side access is preferred for service access. However, all components may be serviced from the front access panel if side access is not available.
- Discharge flange is field installed.
- Condensate is rubber coupling that couples to 3/4" schedule 40/80 PVC.
- Water connections for optional hot water generator are 1/2" FPT.
- Units shipped with filter rails. These rails should be removed for return duct connection. See Aff---- for accessory air filter frame with duct collar.

Legend:

- CAP = Control Access Panel
 BSP = Blower Service Panel
 CSP = Compressor Access Panel
 ASP = Alternative Service Panel (Optional Access, Not Required)

HE – Vertical Upflow Dimensional Data

Vertical Model		Discharge Connection Duct Flange Installed (+/- 0.10 in, +/- 2.5mm)					Return Connection Using Return Air Opening			
		M	N	O Supply Width	P Supply Depth	Q	R	S Return Depth	T Return Height	U
024 - 030	in	7.2	4.2	14.0	14.0	6.7	2.2	18.4	20.3	1.1
	cm	18.3	10.7	35.6	35.6	17.0	5.6	46.7	51.6	2.8
036 - 042	in	7.2	6.0	14.0	14.0	6.5	2.1	22.9	24.3	1.1
	cm	18.3	15.2	35.6	35.6	16.5	5.3	58.2	61.7	2.8
048 - 060	in	8.2	5.7	16.0	18.0	7.3	2.1	26.2	28.3	1.1
	cm	20.8	14.5	40.6	45.7	18.5	5.3	66.5	71.9	2.8

All dimensions are +/- 0.20 in, (+/-5.1 mm).

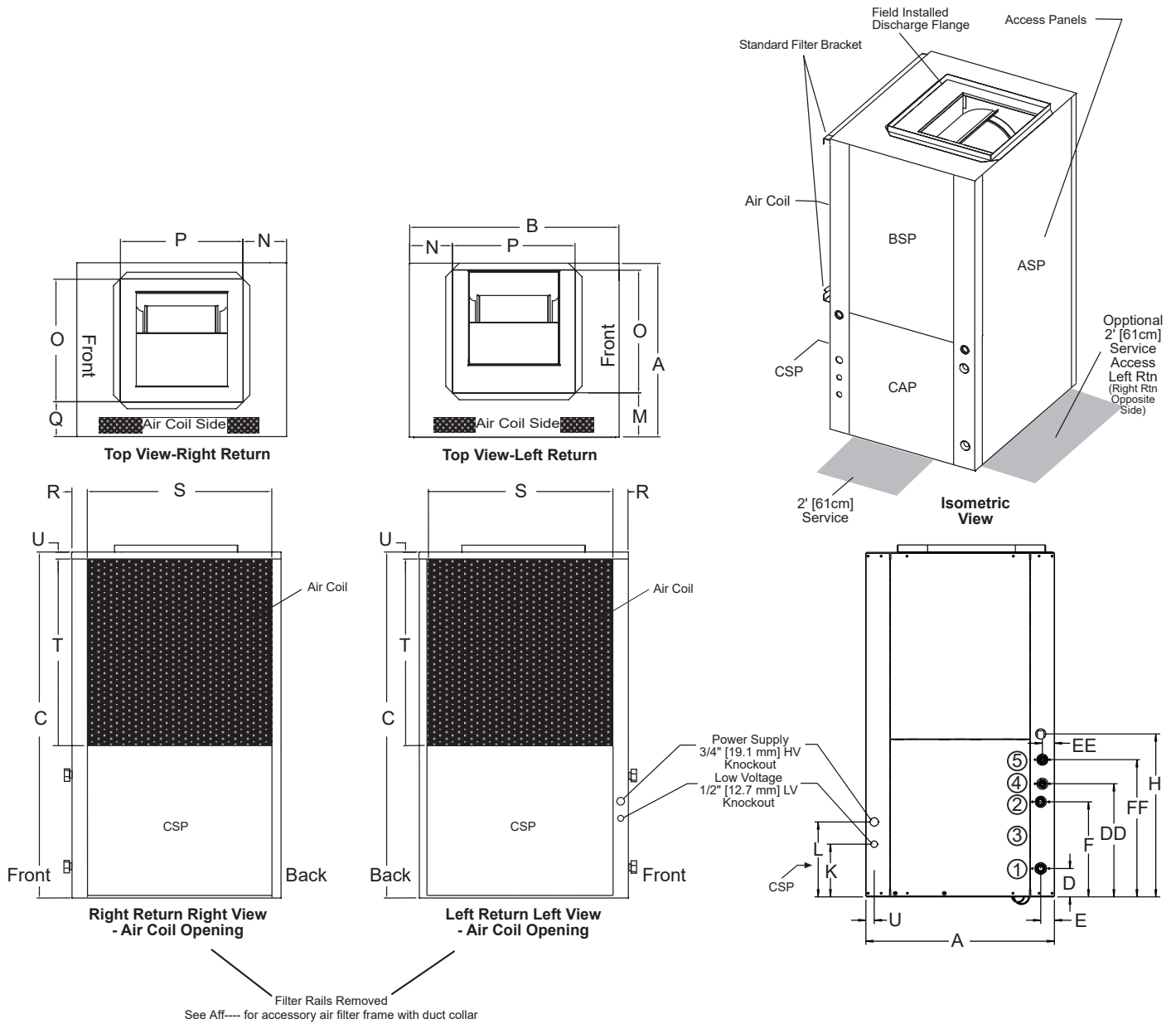

Corner Weights for HE Series Horizontal Units

Model		Total	Left-Front*	Right-Front*	Left-Back*	Right-Back*
024	Lbs	208	68	56	42	42
	kg	94	31	25	19	19
030	Lbs	208	68	56	42	42
	kg	94	31	25	19	19
036	Lbs	233	76	63	47	47
	kg	106	35	29	21	21
042	Lbs	244	80	66	49	49
	kg	111	37	30	22	22
048	Lbs	299	98	81	60	60
	kg	136	45	37	27	27
060	Lbs	314	103	85	63	63
	kg	142	46	38	29	29

*Front is control box end.

Units with Modulating Motorized Valve

Model	Voltage	Min/Max Voltage	Compressor			Fan Motor	Total Unit	Min Circ	Max Fuse/ HACR
			RLA	LRA	Qty	FLA	FLA	Amp	
024	208/230/60/1	197/252	11.7	58.3	1	3.9	15.6	18.5	30
030	208/230/60/1	197/252	13.1	73.0	1	3.9	17.0	20.3	30
036	208/230/60/1	197/252	15.3	83.0	1	3.9	19.2	23.0	35
042	208/230/60/1	197/252	17.9	96.0	1	5.2	23.1	27.6	45
048	208/230/60/1	197/252	21.2	104.0	1	5.2	26.4	31.7	50
060	208/230/60/1	197/252	27.1	152.9	1	6.9	34.0	40.8	60

Wire length based on one way measurement with 2% voltage drop

Wire size based on 60°C copper conductor

All fuses Class RK-5

*** NEUTRAL CONNECTION REQUIRED! All F Voltage (460 vac) units require a four wire power supply with neutral. ECM motor is rated 265 vac and is wired between one hot leg and neutral.**

Units with Internal Secondary Pump

Model	Voltage	Min/Max Voltage	Compressor			Pump Motor	Fan Motor	Total Unit	Min Circ	Max Fuse/ HACR
			RLA	LRA	Qty	FLA	FLA	FLA	Amp	
024	208/230/60/1	197/252	11.7	58.3	1	0.8	3.9	16.4	19.3	30
030	208/230/60/1	197/252	13.1	73.0	1	0.8	3.9	17.8	21.1	30
036	208/230/60/1	197/252	15.3	83.0	1	0.8	3.9	20.0	23.8	35
042	208/230/60/1	197/252	17.9	96.0	1	0.8	5.2	23.9	28.4	45
048	208/230/60/1	197/252	21.2	104.0	1	1.1	5.2	27.5	32.8	50
060	208/230/60/1	197/252	27.1	152.9	1	1.1	6.9	35.1	41.9	60

Wire length based on one way measurement with 2% voltage drop

Wire size based on 60°C copper conductor

All fuses Class RK-5

Units with High Head Variable Pump

Model	Voltage	Min/ Max Voltage	Compressor			Pump Motor FLA	Fan Motor FLA	Total Unit FLA	Min Circ Amp	Max Fuse/ HACR
			RLA	LRA	Qty					
024	208/230/60/1	197/252	11.7	58.3	1	1.44	3.9	17.0	20.0	30
030	208/230/60/1	197/252	14.7	73	1	1.44	3.9	18.4	21.7	35
036	208/230/60/1	197/252	18	83	1	1.44	3.9	20.6	24.5	40
042	208/230/60/1	197/252	21.8	96	1	1.44	5.2	24.5	29.0	45
048	208/230/60/1	197/252	21.2	104	1	1.44	5.2	27.8	33.1	50
060	208/230/60/1	197/252	28.9	152.9	1	1.44	6.9	35.4	42.2	60

Wire length based on one way measurement with 2% voltage drop
Wire size based on 60°C copper conductor
All fuses Class RK-5

Units with Low Head Variable Pump

Model	Voltage	Voltage Min/ Max	Compressor			Pump Motor FLA	Fan Motor FLA	Total Unit FLA	Min Circ Amp	Max Fuse/ HACR
			RLA	LRA	Qty					
024	208/230/60/1	197/252	11.7	58.3	1	0.7	3.9	16.3	19.2	30
030	208/230/60/1	197/252	14.7	73.0	1	0.7	3.9	17.7	21.0	30
036	208/230/60/1	197/252	18.0	83.0	1	0.7	3.9	19.9	23.7	35
042	208/230/60/1	197/252	21.8	96.0	1	0.7	5.2	23.8	28.3	45
048	208/230/60/1	197/252	25.0	104	1	0.7	5.2	27.1	32.4	50
060	208/230/60/1	197/252	28.9	152.9	1	0.7	6.9	34.7	41.5	60

Wire length based on one way measurement with 2% voltage drop
Wire size based on 60°C copper conductor
All fuses Class RK-5

HE Series Wiring Diagram Matrix

All current diagrams can be located online at climatemaster.com/commercial/literature/wiring-diagrams.

Unit Controller	Fan Motor	208v/1 - 230v/1
		HE024 - 060
DXM2	CV ECM	96B0231N11
Auxiliary WD for LON		96B0147N17
Auxiliary WD for MPC		96B0147N14
Control Box Layouts		96B0500N00

LEGEND

	Factory Low Voltage Wiring
	Factory Line Voltage Wiring
	Field Low Voltage Wiring
	Field Line Voltage Wiring
	Primary Circuit Trace
	Optimal Wiring
	Optional Block
	Capacitor
	Control Panel Blower Motor
	Control Panel Jumper
	FI/SE
	Ground
	High Pressure Switch
	LED
	Low Pressure Switch
	Make-N-Lock
	Multi Splice Connector
	Optional
	Relay contacts - N.C.
	Relay contacts - N.O.
	Relay / Contactor Coil
	Solenoid Coil
	Splice Cap
	Temperature Switch
	Thermistor
	Wire Nut

- NOTES**
- Compressor and Blower Motor thermally protected internally.
 - low voltage wiring shall be Class 2 or equivalent.
 - Transformer wiring is voltage sensitive. Use layout corresponding to the unit voltage.
 - LTI provides low temperature protection for WATER. When using ANTI-FREEZE solutions, cut W3 jumper.
 - Typical heat pump thermostat wiring shown. Refer to thermostat IOM for wiring to the unit. T-Stat wiring must be "Class 1" and voltage rating equal to or greater than unit supply voltage.
 - 250 C.A. 300V 1000µF Capacitor (C1).
 - Transformer Secondary Ground via CXM/DXM board standoffs and screws to Control Box.

ECM1: For ECM Blower Motor air flow adjustment and diagnostic information refer to I.O.M.

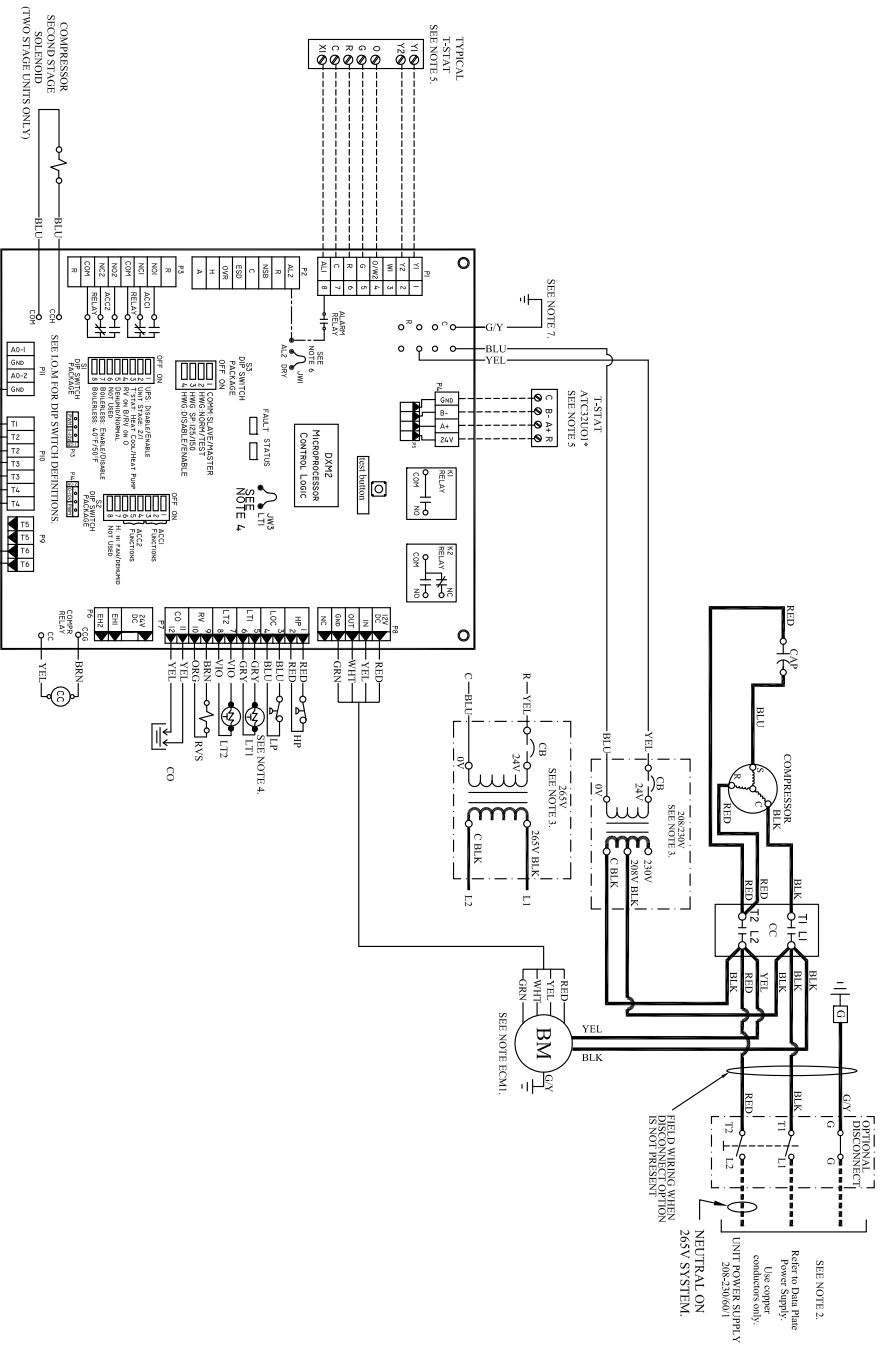

ACO	Automatic Change Over
AMS	Airamp Relay Capases
AMS	Airamp Relay System
BMI	Blower Motor
BMC	Blower Motor Capacitor
BRP	Blower Relay
CB	Circuit Breaker
CC	Compressor Contactor
CDT	Compressor Discharge Temperature
CR	Compressor Relay
CRC	Compressor Relay Capacitor
CS	Current Sensor
DWI	Dimmer Motor
DMS	Discharge Temperature Switch
DTS	Discharge Temperature Switch
EBV	Electronic Expansion Valve
EHC	Electronic Heat Exchanger
ETC	Electronic Temperature Control
EWT	Entering Water Temp Sensor
FSK	Fan Speed Switch
FSK	Fan Speed Switch
HP	High Pressure Water Switch
HPWS	High Pressure Water Switch
JW	Jumper Wire
LAT	Leaving Air Temperature
LAP	Low Pressure Switch
LTP	Low Pressure Switch
LTI	Sensor, low temp protection, water coil
LTI	Sensor, low temp protection, air coil
LTT	Sensor, low temp protection, water coil
LTT	Sensor, low temp protection, air coil
LUT	Low Pressure Switch
MCO	Manual Change Over
MOD	Modulating Water Valve
MS	Main Starter
MS	Main Starter
MSC	Modular Water Valve
MWV	Modular Water Valve
NLL	Night Low Limit Switch
PDB	Power Distribution Block
POT	Potentiometer
PR	Pressure
PR	Pressure
PR	Pressure
RAS	Rearm Air Sensor
RVS	Reversing Valve Solenoid
SAC	Start Assist Capacitor
SAS	Supply Air Sensor
SAS	Supply Air Sensor
TRANS	Transformer
UNIT	Unit Mounted Thermostat
VFD	Variable Frequency Drive
WSP	Water Speed Pump
WSPAT	Water Stat

SEE NOTE 2.
Refer to Data plate
Power Supply:
Use copper
conductors only.
UNIT POWER SUPPLY
208-230/60/1
NEUTRAL ON
265V SYSTEM
FIELD WIRING WHEN
DISCONNECT OPTION
IS NOT PRESENT

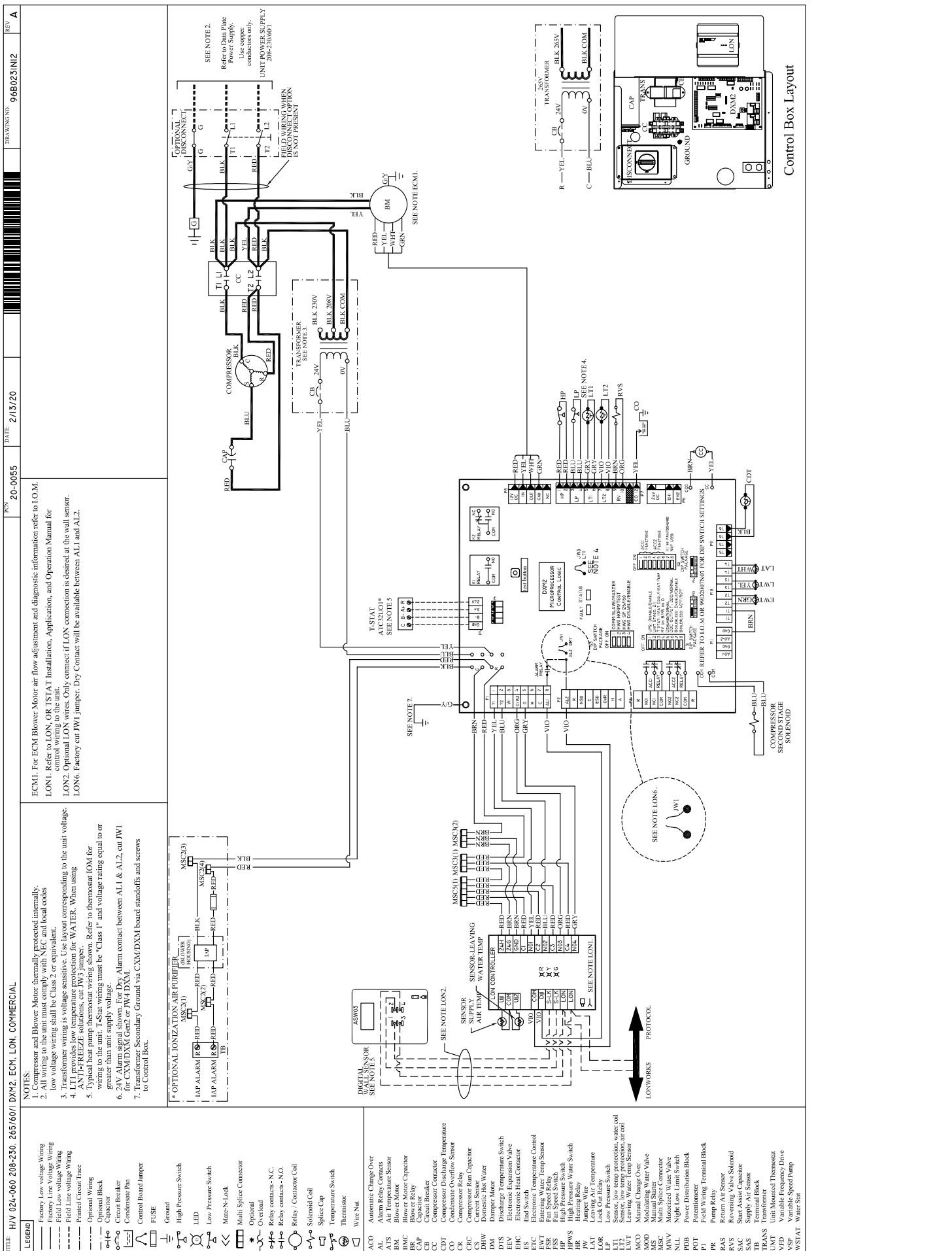

LEGEND

- Factory Low Voltage Wiring
- Factory Line Voltage Wiring
- Field Low Voltage Wiring
- Field Line Voltage Wiring
- Printed Circuit Trace
- Optional Wiring
- Optional Block
- Circuit Breaker
- Control Board Jumper
- FUSE
- Ground
- High Pressure Switch
- LED
- Low Pressure Switch
- Make-to-lock
- Make-to-lock
- Multi Splice Connector
- Optional
- Overload
- Relay contacts - N.C.
- Relay contacts - N.O.
- Relay / Contactor Coil
- Solenoid Coil
- Splice Cap
- Temperature Switch
- Thermostat
- Wire Nut

- NOTES:**
- Compressor and Blower Motor thermally protected internally.
 - All wiring of the motor shall be empty with NCS and heat coats.
 - Transformer wiring is voltage sensitive. Use layout corresponding to the unit voltage.
 - L1/L1 provides low temperature protection for WATER. When using ANTI-FREEZE solutions, cut IW3 jumper.
 - Typical heat pump thermostat wiring shown. Refer to thermostat IOW for wiring to the unit. 1-5 star wiring must be "Class 1" and voltage rating equal to or greater than unit supply voltage.
 - 24V Alarm signal shown. For Dry Alarm contact between AL1 & AL2, cut IW1 for CAS/DXN Gnd2 or MW DXN.
 - Secondary Ground via CMM/DXM board standards and screws to Control Box.

ECM1: For ECM Blower Motor air flow adjustment and diagnostic information refer to IOM.
 MPC2: Refer to MPC Installation application, and Operation Manual For Control Wiring to the unit.
 MPC3: ASW sensors are not required on Water-Water application. ASW06-ASW08 (Water-Air DM) move jumper to LST41. ASW09-ASW11 move jumper to Rec. MPC8: Factory cut JW1 jumper. Dry Contact will be available between AL1 and AL2.

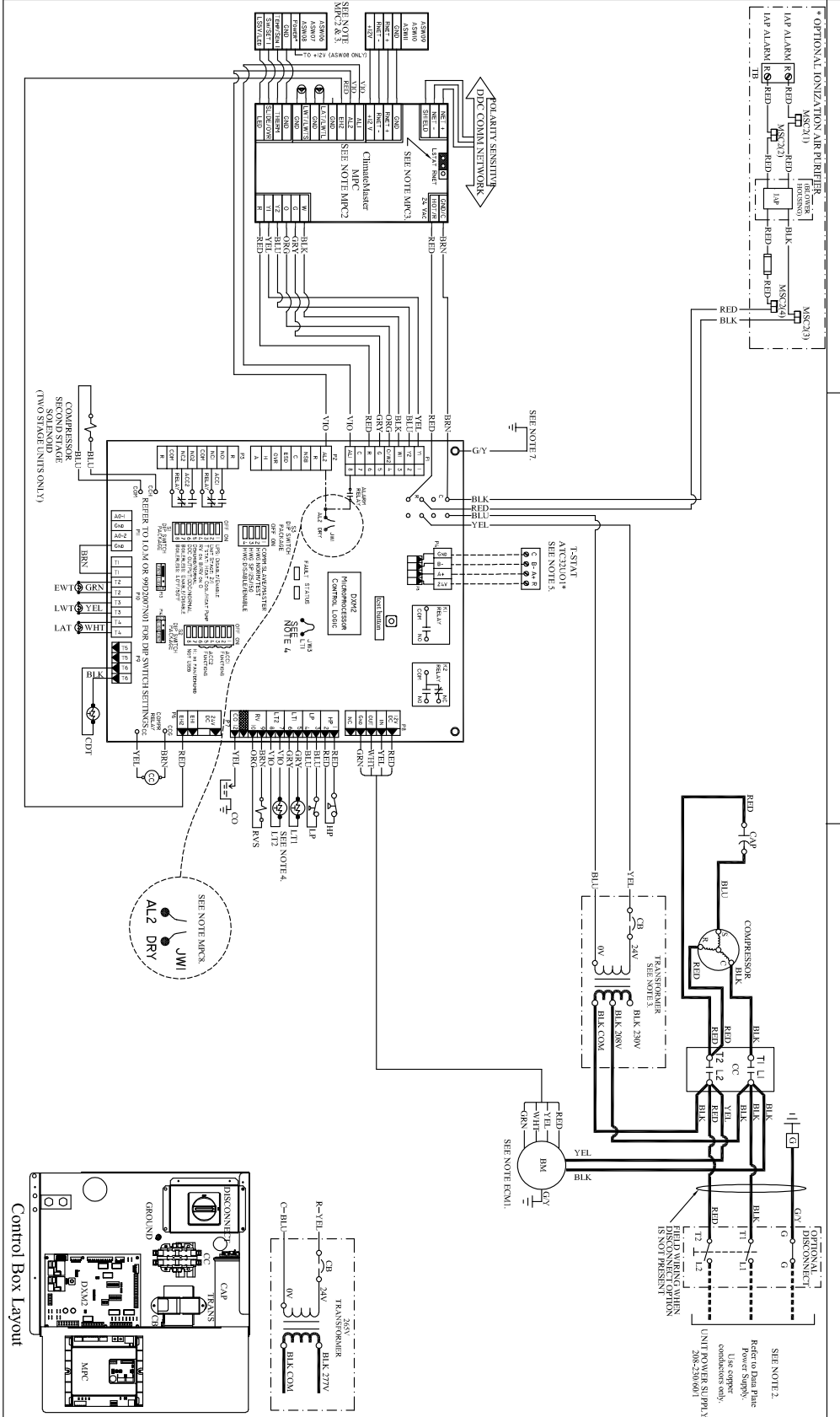

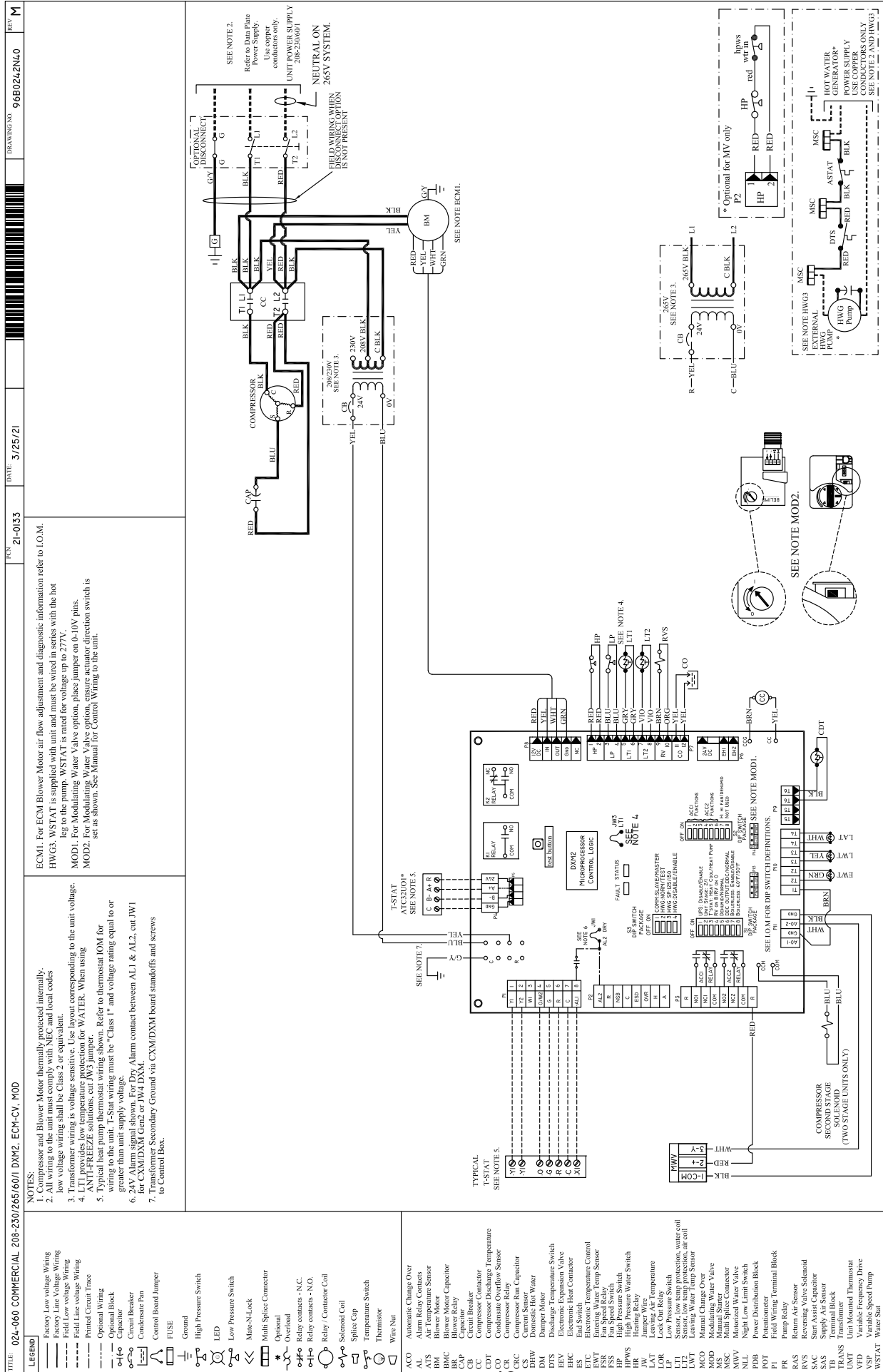

LEGEND	
—	Factory Low Voltage Wiring
---	Factory Line Voltage Wiring
- - -	Field low voltage wiring
- - -	Field line voltage wiring
- - -	Printed Circuit trace
- - -	Optional Wiring
○	Optional Block
○	Compressor fan
○	Control Board Jumper
○	FUSE
○	Ground
○	High Pressure Switch
○	LED
○	Low Pressure Switch
○	Make-Sure Lock
○	Multi Splice Connector
○	Optional
○	Optional Relay connect - N.C.
○	Relay connect - N.O.
○	Relay/Contactor Coil
○	Soldered Coil
○	Splice Cap
○	Temperature Switch
○	Thermistor
○	Wire Nut

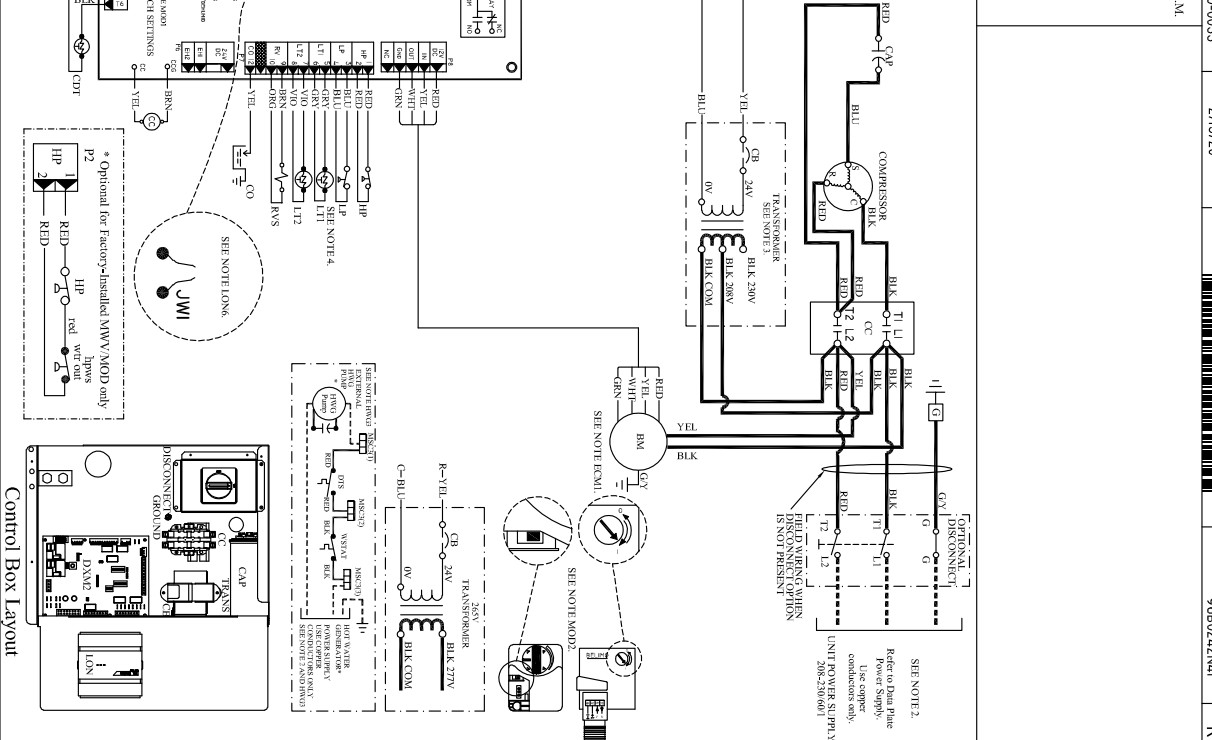
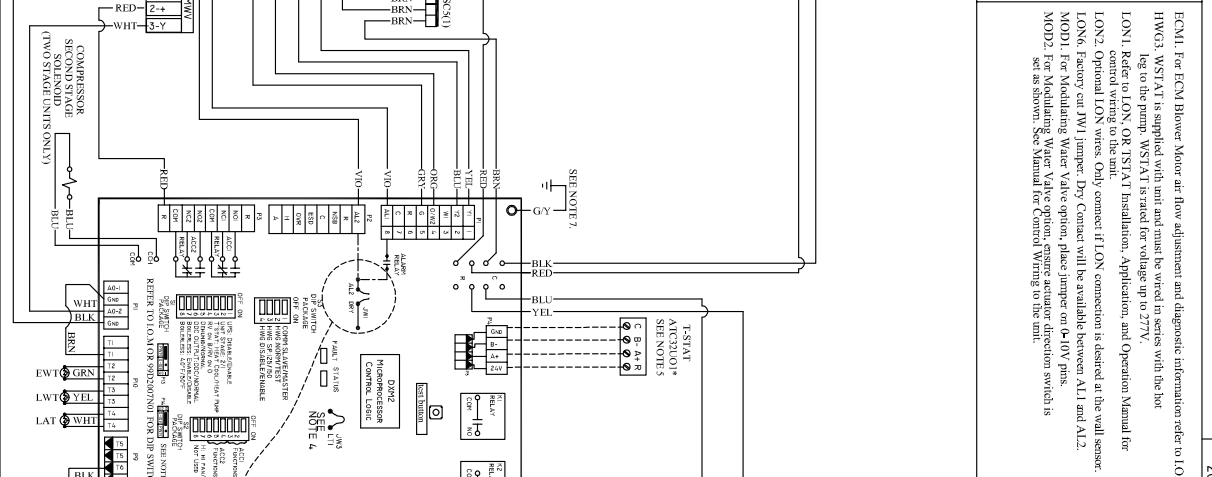
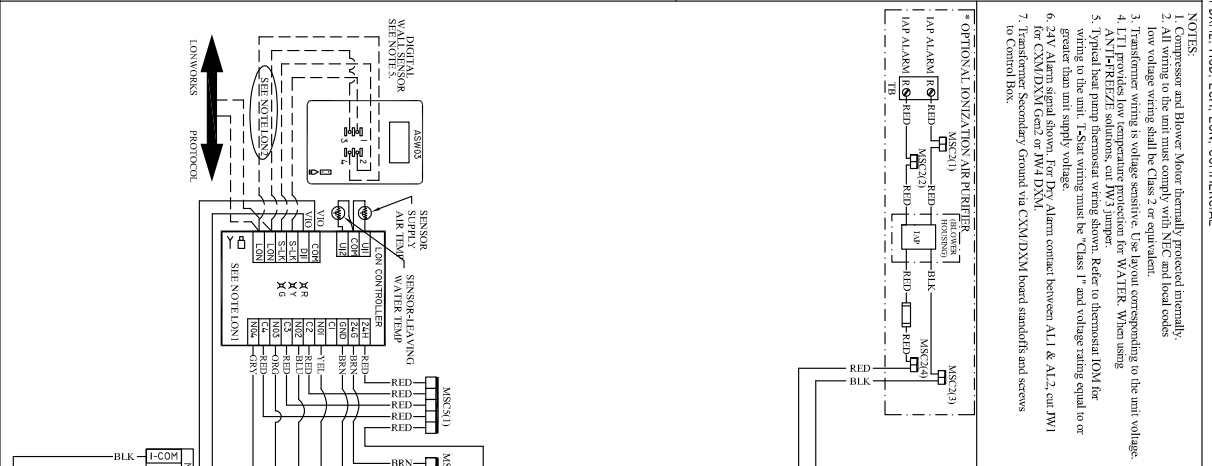

Control Box Layout

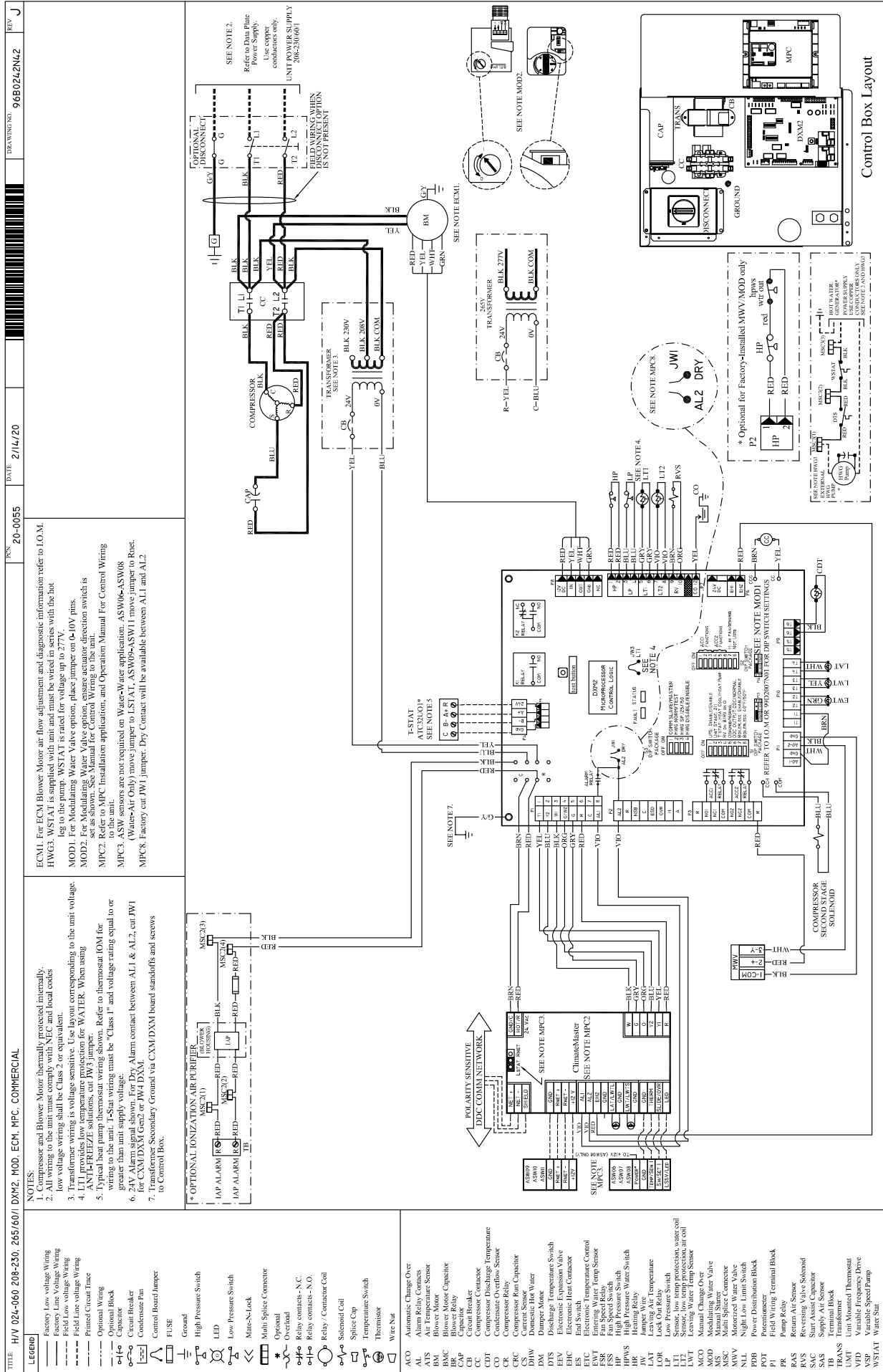

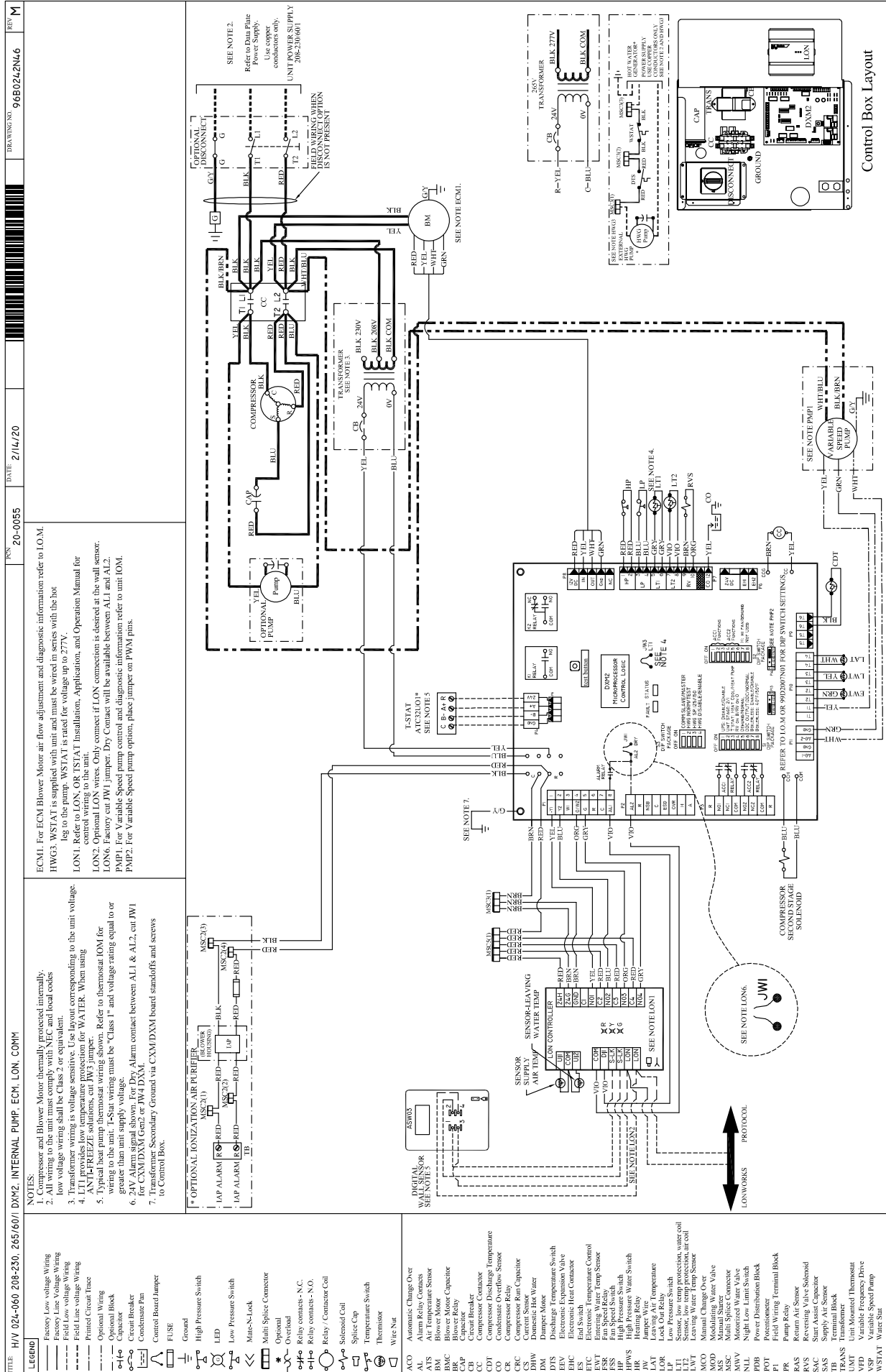

Legend	Legend
Factory Low Voltage Wiring	High Pressure Switch
Factory Line Voltage Wiring	LED
Field Low Voltage Wiring	Low Pressure Switch
Field Line Voltage Wiring	Make-Break
Printed Circuit Trace	Multi Splice Connector
Optional Wiring	Optional
Optional Break	Relay contacts -N.C.
Capacitor	Relay contacts -N.O.
Control Board	Relay / Contactor Coil
Control Board Jumper	Standard Coil
FLPSE	Splice Cap
Ground	Temperature Switch
Ground	Thermistor
Wire Nut	Wire Nut

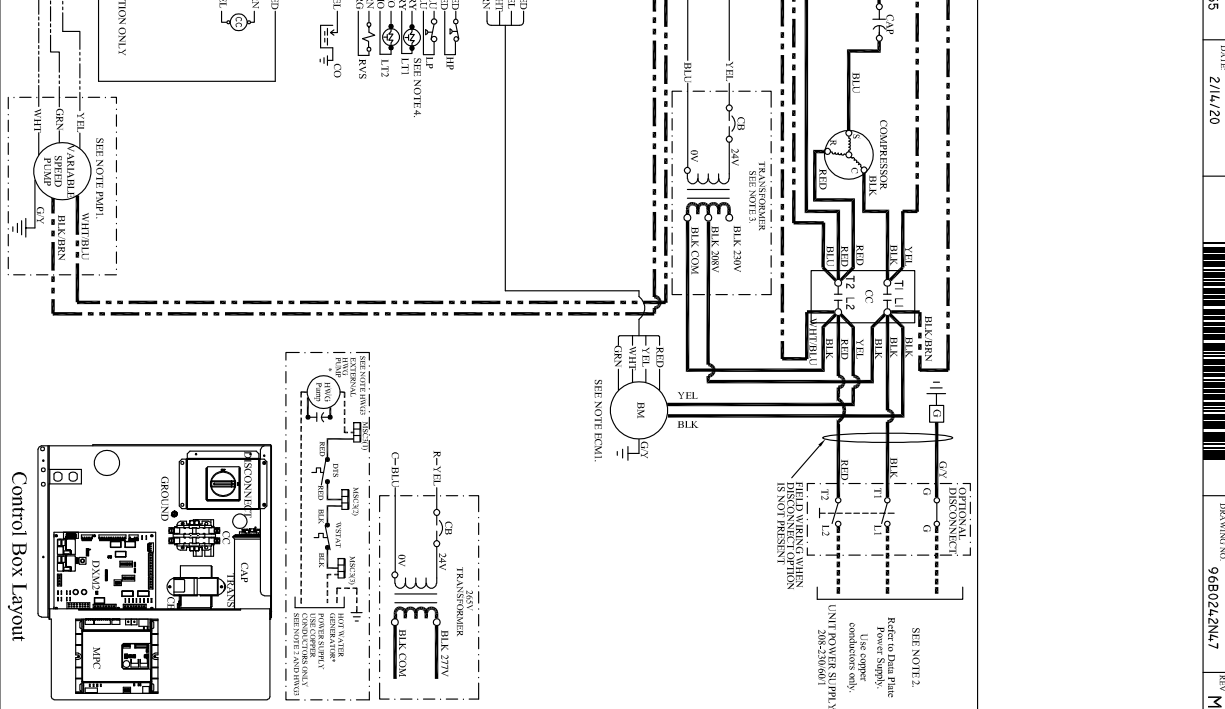
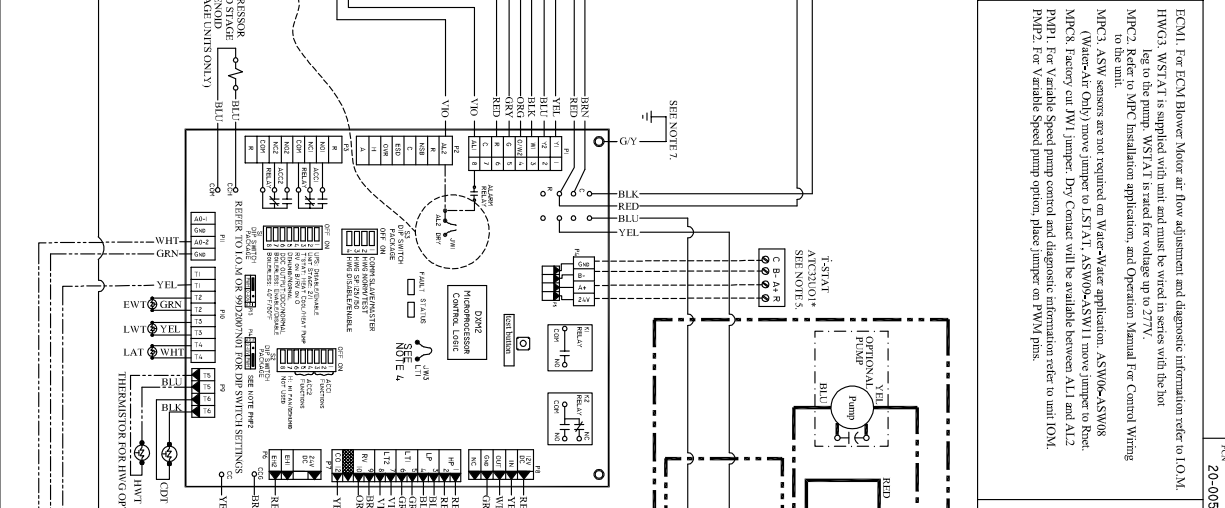
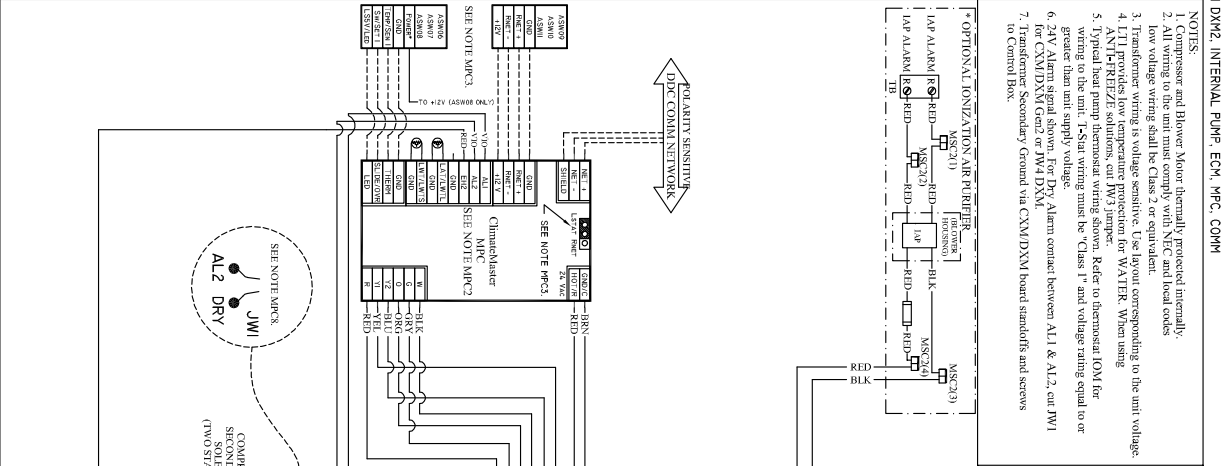

HE Series 60Hz Engineering Specifications – Page 1

General:

Furnish and install Comfort-Aire and Century "HE" Water Source Heat Pumps, as indicated on the plans. Equipment shall be completely assembled, piped, and internally wired. Capacities and characteristics as listed in the schedule and the specifications that follow.

Units shall be supplied completely factory built capable of operating over an entering water temperature range from 20° to 120° F (-6.7° to 48.9° C) as standard. Equivalent units from other manufacturers may be proposed provided approval to bid is given 10 days prior to bid closing. All equipment listed in this section must be rated and certified in accordance with Air-Conditioning, Heating and Refrigeration Institute/International Standards Organization (AHRI/ISO 13256-1). All equipment must be tested, investigated, and determined to comply with the requirements of the standards for Heating and Cooling Equipment UL-1995 for the United States and CAN/CSA-C22.2 NO.236 for Canada, by Intertek Testing Laboratories (ETL). The units shall have AHRI/ISO and ETL-US-C labels.

All units shall pass a factory acceptance test. The quality control system shall automatically perform the factory acceptance test via computer. A detailed report card from the factory acceptance test shall ship with each unit. **(Note: If unit fails the factory acceptance test it shall not be allowed to ship. Unit serial number will be recorded by factory acceptance test and furnished on report card for ease of unit warranty status.)**

Basic Construction:

Horizontal units shall have one of the following air flow arrangements: Left Inlet/Straight (Right) Discharge; Right Inlet/Straight (Left) Discharge; Left Inlet/Back Discharge; or Right Inlet/Back Discharge as shown on the plans. Units must have the ability to be field convertible from straight to back or back to straight discharge with no additional parts or unit structure modification. Horizontal units will have factory installed hanger brackets with rubber isolation grommets packaged separately.

Vertical Units shall have one of the following air flow arrangements: Left Return/Top Discharge, Right Return/Top Discharge, as shown on the plans.

If units with these arrangements are not used, the contractor is responsible for any extra costs incurred by other trades. All units (horizontal and vertical) must have multiple access panels for serviceability of compressor compartment. **Units having only one access panel to compressor/heat exchangers/expansion device/refrigerant piping shall not be acceptable.**

Compressor section interior surfaces shall be lined with 1/2 inch (12.7mm) thick, 1-1/2 lb/ft³ (24 kg/m³) acoustic type glass fiber insulation. Air handling section interior surfaces shall be lined with 1/2 inch (12.7mm) thick, 1-1/2 lb/ft³ (24 kg/m³) foil-faced fiber insulation for ease of cleaning. Insulation placement shall be designed in a manner that will eliminate any exposed edges to prevent the introduction of glass fibers into the air stream. **Units without foil-faced insulation in the air handling section will not be accepted.**

The heat pump cabinets shall be fabricated from heavy gauge galvanized steel.

Standard insulation must meet NFPA Fire Hazard Classification requirements 25/50 per ASTM E84, UL 723, CAN/ULC S102-M88 and NFPA 90A requirements; air erosion and mold growth limits of UL-181; stringent fungal resistance test per ASTM-C1071 and ASTM G21; and shall meet zero level bacteria growth per ASTM G22. **Unit insulation must meet these stringent requirements or unit(s) will not be accepted.**

All horizontal units to have factory installed 1 inch (25.4 mm) discharge air duct collars, 1 inch (25.4 mm) filter rails with 1 inch (25.4 mm) filters factory installed, and factory installed unit-mounting brackets. Vertical units to have field installed discharge air duct collar, shipped loose and 1 inch (25.4 mm) filter rails with 1 inch (25.4 mm) filters factory installed. **If units with these factory-installed provisions are not used, the contractor is responsible for any extra costs to field install these provisions, and/or the extra costs for his sub-contractor to install these provisions.**

HE Series 60Hz Engineering Specifications – Page 2

All units must have an insulated panel separating the fan compartment from the compressor compartment. **Units with the compressor in the air stream are not acceptable.** Units shall have a factory installed 1 inch (25.4 mm) wide filter bracket for filter removal from either side. Units shall have a 1 inch (25.4 mm) thick throwaway type glass fiber filter. The contractor shall purchase one spare set of filters and replace factory shipped filters on completion of start-up. Filters shall be standard sizes. If units utilize non-standard filter sizes then the contractor shall provide 12 spare filters for each unit.

Cabinets shall have separate holes and knockouts for entrance of line voltage and low voltage control wiring. All factory-installed wiring passing through factory knockouts and openings shall be protected from sheet metal edges at openings by plastic ferrules. Supply and return water connections shall be copper FPT fittings, and shall be securely mounted flush to the cabinet corner post allowing for connection to a flexible hose without the use of a back-up wrench. **Water connections that protrude through the cabinet or require the use of a backup wrench shall not be allowed.** All water connections and electrical knockouts must be in the compressor compartment corner post as to not interfere with the serviceability of unit. Contractor shall be responsible for any extra costs involved in the installation of units that do not have this feature. Contractor must ensure that units can be easily removed for servicing and coordinate locations of electrical conduit and lights with the electrical contractor.

Option: The contractor shall install 1 inch MERV rated pleated media disposable air filters on all units.

Option: The unit will be supplied with internally factory mounted modulating water valve with delta T control. The factory built-in valve shall modulate water flow through unit based on a field adjustable water temperature difference between the entering and leaving water. For two-stage units, the modulating valve will automatically reduce the water flow through the unit during part load operation to maintain the configured temperature difference. The valve shall automatically adjust for operating mode, stage of capacity, source water temperature and variations in external head pressure. The valve will also act as a shut-off valve to prevent water flow through the unit when the unit is not activated and will have a minimum position capability. Externally mounted modulating water valves will not be accepted.

Option: The unit will be supplied with internally factory mounted variable speed water circulating pump with internal check valve. The variable speed pump shall modulate water flow through the unit based on a field adjustable temperature difference between the entering and leaving water. For two-stage units, the modulating valve will automatically reduce the water flow through the unit during part load operation to maintain the configured temperature difference. The variable speed pump shall automatically adjust for operating mode, stage of capacity, source water temperature, and variations in external head pressure. Externally mounted circulating pumps will not be accepted.

Option: The unit will be supplied with internally mounted secondary pump for primary/secondary applications, including one-pipe systems. Externally mounted secondary pump will not be accepted.

Fan and Motor Assembly:

Blower shall have inlet rings to allow removal of wheel and motor from one side without removing housing. Units shall have a direct-drive centrifugal fan. The fan motor shall be an ECM variable speed ball bearing type motor. The ECM fan motor shall provide soft starting, maintain constant CFM over its static operating range and provide airflow adjustment in 25 CFM increments via its control board. The fan motor shall be isolated from the housing by rubber grommets. The motor shall be permanently lubricated and have thermal overload protection. A special dehumidification mode shall be provided to allow lower airflows in cooling for better

HE Series 60Hz Engineering Specifications – Page 3

dehumidification. The dehumidification mode may be constant or automatic (humidistat controlled). Airflow/Static pressure rating of the unit shall be based on a wet coil and a clean filter in place. **Ratings based on a dry coil, and/or no air filter, shall NOT be acceptable.**

Refrigerant Circuit:

All units shall contain an EarthPure®(HFC-410A) sealed refrigerant circuit including a high efficiency two-stage scroll compressor designed for heat pump operation, a thermostatic expansion valve for refrigerant metering, an enhanced corrugated aluminum lanced fin and rifled copper tube refrigerant to air heat exchanger, reversing valve, coaxial (tube in tube) refrigerant to water heat exchanger, and safety controls including a high pressure switch, low pressure switch (loss of charge), water coil low temperature sensor, and air coil low temperature sensor. Access fittings shall be factory installed on high and low pressure refrigerant lines to facilitate field service. Activation of any safety device shall prevent compressor operation via a microprocessor lockout circuit. The lockout circuit shall be reset at the thermostat or at the contractor supplied disconnect switch. **Units that cannot be reset at the thermostat shall not be acceptable.**

Hermetic compressors shall be internally sprung. The compressor shall have a dual level vibration isolation system. The compressor will be mounted on specially engineered sound-tested EPDM vibration isolation grommets to a large heavy gauge compressor mounting plate, which is then isolated from the cabinet base with rubber grommets for maximized vibration attenuation. All units shall include a discharge muffler to further enhance sound attenuation. Compressor shall have thermal overload protection. Compressor shall be located in an insulated compartment away from air stream to minimize sound transmission.

Refrigerant to air heat exchangers shall utilize enhanced corrugated lanced aluminum fins and rifled copper tube construction rated to withstand 625 PSIG (4309 kPa) refrigerant working pressure. Refrigerant to water heat exchangers shall be of copper inner water tube and steel refrigerant outer tube design, rated to withstand 625 PSIG (4309 kPa) working refrigerant pressure and 500 PSIG (3445 kPa) working water pressure. The refrigerant to water heat exchanger shall be “electro-coated” with a low cure cathodic epoxy material a minimum of 0.4 mils thick (0.4 – 1.5 mils range) on all surfaces. The black colored coating shall provide a minimum of 1,000 hours salt spray protection per ASTM B117-97 on all external steel and copper tubing. The material shall be formulated without the inclusion of any heavy metals and shall exhibit a pencil hardness of 2H (ASTM D3363-92A), crosshatch adhesion of 4B-5B (ASTM D3359-95), and impact resistance of 160 in-lbs (184 kg-cm) direct (ASTM D2794-93).

Refrigerant metering shall be accomplished by thermostatic expansion valve only. Expansion valves shall be dual port balanced types with external equalizer for optimum refrigerant metering. Units shall be designed and tested for operating ranges of entering water temperatures from 20° to 120° F (-6.7° to 48.9° C). Reversing valve shall be four-way solenoid activated refrigerant valve, which shall default to heating mode should the solenoid fail to function. If the reversing valve solenoid defaults to cooling mode, an additional low temperature thermostat must be provided to prevent over-cooling an already cold room.

Option: The unit will be supplied with a cupro-nickel coaxial water to refrigerant heat exchanger.

Option: The unit shall be supplied with a hot water generator (desuperheater).

Option: The refrigerant to air heat exchanger shall be tin-plated.

Drain Pan:

The drain pan shall be constructed of stainless steel that inhibits corrosion. If galvanized steel drain pan is used, it shall be fully insulated on all sides and must meet the stringent 1,000 hour salt spray test per ASTM B117. Drain outlet shall be located at pan as to allow unobstructed drainage of condensate. Drain outlet shall be connected from pan directly to a MPT fitting. **No hidden internal tubing extensions from pan outlet extending to unit casing (that can create drainage problems) will be accepted.** The unit as standard will be supplied with solid-state electronic condensate overflow protection. **Mechanical float switches will NOT be accepted.**

HE Series 60Hz Engineering Specifications – Page 4

Electrical:

A control box shall be located within the unit compressor compartment and shall contain a 75 VA transformer, 24 volt activated, 2 or 3 pole compressor contactor, terminal block for thermostat wiring and solid-state controller for complete unit operation. Reversing valve and fan motor wiring shall be routed through this electronic controller. Units shall be name-plated for use with time delay fuses or HACR circuit breakers. Unit controls shall be 24 Volt and provide heating or cooling as required by the remote thermostat/sensor.

Solid State Control System (DXM2):

Units shall have a solid-state control system. **Units utilizing electro-mechanical control shall not be acceptable.** The control system microprocessor board shall be specifically designed to protect against building electrical system noise contamination, EMI, and RFI interference. The control system shall have the following features:

- Anti-short cycle time delay on compressor operation.
- Random start on power up mode.
- Low voltage protection.
- High voltage protection.
- Unit shutdown on high or low refrigerant pressures.
- Unit shutdown on low water temperature.
- Condensate overflow electronic protection.
- Option to reset unit at thermostat or disconnect.
- Automatic intelligent reset. Unit shall automatically reset the unit 5 minutes after trip if the fault has cleared. If a fault occurs 3 times sequentially without thermostat meeting temperature, then lockout requiring manual reset will occur.
- Ability to defeat time delays for servicing.
- Light emitting diode (LED) on circuit board to indicate high pressure, low pressure, low voltage, high voltage, low water/air temperature cut-out, condensate overflow, and control voltage status.
- The low-pressure switch shall not be monitored for the first 120 seconds after a compressor start command to prevent nuisance safety trips.
- 24 V output to cycle a motorized water valve or other device with compressor contactor.
- Unit Performance Sentinel (UPS). The UPS warns when the heat pump is running inefficiently.
- Water coil low temperature sensing (selectable for water or antifreeze).
- Air coil low temperature sensing.
- Removable thermostat connector.
- Night setback control.
- Random start on return from night setback.
- Minimized reversing valve operation (Unit control logic shall only switch the reversing valve when cooling is demanded for the first time. The reversing valve shall be held in this position until the first call for heating, ensuring quiet operation and increased valve life.).
- Override temperature control with 2-hour timer for room occupant to override setback temperature at the thermostat.
- Dry contact night setback output for digital night setback thermostats.
- Ability to work with heat pump (Y, O) or heat/cool (Y, W) type thermostats.
- Ability to work with heat pump thermostats using O or B reversing valve control.
- Emergency shutdown contacts.
- Boilerless system heat control at low loop water temperature.
- Ability to allow up to 3 units to be controlled by one thermostat.
- Relay to operate an external damper.
- Ability to automatically change fan speed from multi-stage thermostat.

HE Series 60Hz Engineering Specifications – Page 5

- Relay to start system pump.
- 75 VA control transformer. Control transformer shall have load side short circuit and overload protection via a built in circuit breaker.

NOTE: Units not providing the 8 safety protections of anti-short cycle, low voltage, high voltage, high refrigerant pressure, low pressure (loss of charge), air coil low temperature cut-out, water coil low temperature cut-out, and condensate overflow protections will not be accepted.

NOTE: To achieve full benefit of the two-stage compressor and ECM fan, a 2 Heat/2 Cool thermostat (or a 3 Heat/2 Cool thermostat when electric backup heat is required) should be employed.

This control system coupled with a multi-stage thermostat will better dehumidify room air by automatically running the heat pump's fan at lower speed on the first stage of cooling thereby implementing low sensible heat ratio cooling. On the need for higher cooling performance the system will activate the second stage of cooling and automatically switch the fan to the higher fan speed setting. This system may be further enhanced with a humidistat. **Units not having automatic low sensible heat ratio cooling will not be accepted; as an alternate a hot gas reheat coil may be provided with control system for automatic activation.**

When DXM2 is connected to either 7602-444 service tool or 7602-457 thermostat the installer/service technician can; check and set CFM; check dip switch S1, S2, and S3 settings; run operation modes manually; check all physical inputs from thermostat and refrigerant pressure switches status, (Y1, Y2, W, O, G, H, ESD, NSB, OR, HP switch, and LOC switch); current or at time of fault the following temperatures -LT1, LT2, compressor discharge, leaving air, leaving water, entering water and control voltage; record last five faults, list possible reasons, and clear faults.

Digital Night Setback with Pump Restart (with either 7602-457 Thermostat):

The unit will be provided with a Digital Night Setback feature using an accessory relay on the DXM2 controller and an external, field-provided time clock. The external time clock will initiate and terminate the night setback period. The thermostat will have a night setback override feature with a programmable override time period.

An additional accessory relay on the unit DXM2 controller will energize the building loop pump control for the duration of the override period. **(Note: This feature requires additional low voltage wiring. Consult Application Drawings for details.)**

Remote Service Sentinel:

Solid state control system shall communicate with thermostat to display (at the thermostat) the unit status, fault status, and specific fault condition, as well as retrieve previously stored fault that caused unit shutdown. The Remote Service Sentinel allows building maintenance personnel or service personnel to diagnose unit from the wall thermostat. The control board shall provide a signal to the thermostat fault light, indicating a lockout. Upon cycling the G (fan) input 3 times within a 60 second time period, the fault light shall display the specific code as indicated by a sequence of flashes. A detailed flashing code shall be provided at the thermostat LED to display unit status and specific fault status such as over/under voltage fault, high pressure fault, low pressure fault, low water temperature fault, condensate overflow fault, etc. Units that do not provide this remote service sentinel shall not be acceptable.

HE Series 60Hz Engineering Specifications – Page 6

Option: MPC (Multiple Protocol Control) Interface System

Units shall have all the features listed above and the control board will be supplied with a Multiple Protocol interface board. Available protocols are BACnet MS/TP, Modbus, or Johnson Controls N2. The choice of protocol shall be field selectable/changeable via the use of a simple selector switch. **Protocol selection shall not require any additional programming or special external hardware or software tools.** This will permit all units to be daisy chain connected by a 2-wire twisted pair shielded cable. The following points must be available at a central or remote computer location:

- a. space temperature
- b. leaving water temperature
- c. discharge air temperature
- d. command of space temperature setpoint
- e. cooling status
- f. heating status
- g. low temperature sensor alarm
- h. low pressure sensor alarm
- i. high pressure switch alarm
- j. condensate overflow alarm
- k. hi/low voltage alarm
- l. fan "ON/AUTO" position of space thermostat as specified above
- m. unoccupied/occupied command
- n. cooling command
- o. heating command
- p. fan "ON/AUTO" command
- q. fault reset command
- r. itemized fault code revealing reason for specific shutdown fault (any one of 7)

HE Series 60Hz Engineering Specifications – Page 7

FIELD INSTALLED OPTIONS

Hose Kits:

All units shall be connected with hoses. The hoses shall be 2 feet (61 cm) long, braided stainless steel; fire rated hoses complete with adapters. Only fire rated hoses will be accepted.

Valves:

The following valves are available and will be shipped loose:

- a. Ball valve; bronze material, standard port full flow design, FPT connections.
- b. Ball valve with memory stop and PT port.
- c. “Y” strainer with blowdown valve; bronze material, FPT connections.
- d. Motorized water valve; slow acting, 24 V, FPT connections.

Hose Kit Assemblies:

The following assemblies ship with the valves already assembled to the hose described:

- a. Supply and return hoses having ball valve with PT port.
- b. Supply hose having ball valve with PT port; return hose having automatic flow regulator valve with PT ports, and ball valve.
- c. Supply hose having “Y” strainer with blowdown valve, and ball valve with PT port; return hose having automatic flow regulator with PT ports, and ball valve.
- d. Supply hose having “Y” strainer with blowdown valve, and ball valve with PT port; return hose having ball valve with PT port.

Thermostats:

The thermostat shall be a Comfort-Aire/Century mechanical or electronic type thermostat as selected below with the described features:

a. Thermostat (communicating) (7602-457)

An electronic communicating LCD thermostat shall be provided. The thermostat shall offer three stages of heating and two stages of cooling with precise temperature control and have a four-wire connection to the unit. The thermostat shall be capable of manual or automatic change-over operation and shall operate in standard or programmable mode. An integrated humidity control feature shall be included to control a humidifier and/or a dehumidifier. The thermostat shall include a utility demand reduction feature to be initiated by an independent time program or an external input.

The thermostat shall have a comprehensive installation setup menu to include configuration of the unit CFM for each mode of operation and configuration of the water flow rate through the unit, including variation of the water flow rate based on the stage of unit operation.

The thermostat shall display system faults with probable cause and troubleshooting guidance. Comprehensive service diagnostics menus shall display, system inputs, system outputs, configuration settings, Geo source inlet and outlet temperatures, compressor discharge line temperature, liquid line temperature, leaving air temperature, and entering potable water temperature (on units equipped with a Hot Water Generator). The thermostat shall allow for immediate manual control of all DXM2 outputs at the thermostat for rapid troubleshooting.

HE Series 60Hz Engineering Specifications – Page 8

DDC Sensors:

Comfort-Aire and Century wall mounted DDC sensor to monitor room temperature and interfaces with optional interface system described above. Several types as described below:

- a. Sensor only with no display (LON and MPC).
- b. Sensor with override (LON only).
- c. Sensor with setpoint adjustment and override (MPC only).
- d. Sensor with setpoint adjustment and override, LCD display, status/fault indication (LON and MPC).

NOTICE! This product specification document is furnished as a means to copy and paste Comfort-Aire and Century product information into project specification. It is not intended to be a complete list of product requirements. This document is an excerpt from the product submittal and must not be used without consulting the complete product submittal. For complete product installation and application requirements, please consult the complete product submittal. Comfort-Aire and Century are not responsible for misuse of this document or a failure to adequately review specific requirements in the product submittal.

Performance Sheet

SUBMITTAL DATA - S-I UNITS

Unit Designation: _____

Job Name: _____

Architect: _____

Engineer: _____

Contractor: _____

PERFORMANCE DATA

Cooling Capacity: _____ kW

EER: _____

Heating Capacity: _____ kW

COP: _____

Ambient Air Temp: _____ °C

Entering Water Temp (Clg): _____ °C

Entering Air Temp (Clg): _____ °C

Entering Water Temp (Htg): _____ °C

Entering Air Temp (Htg): _____ °C

Airflow: _____ l/s

Fan Speed or Motor/RPM/Turns: _____

Operating Weight: _____ (kg)

ELECTRICAL DATA

Power Supply: _____ Volts

_____ Phase _____ Hz

Minimum Circuit Ampacity: _____

Maximum Overcurrent Protection: _____

SUBMITTAL DATA - I-P UNITS

Unit Designation: _____

Job Name: _____

Architect: _____

Engineer: _____

Contractor: _____

PERFORMANCE DATA

Cooling Capacity: _____ Btuh

EER: _____

Heating Capacity: _____ Btuh

COP: _____

Ambient Air Temp: _____ °F

Entering Water Temp (Clg): _____ °F

Entering Air Temp (Clg): _____ °F

Entering Water Temp (Htg): _____ °F

Entering Air Temp (Htg): _____ °F

Airflow: _____ CFM

Fan Speed or Motor/RPM/Turns: _____

Operating Weight: _____ (lb)

ELECTRICAL DATA

Power Supply: _____ Volts

_____ Phase _____ Hz

Minimum Circuit Ampacity: _____

Maximum Overcurrent Protection: _____

Revision History

Date:	Item:	Action:
08/25/21	Engineering Specs	Added drain pan insulation text
07/08/21	Created	

PAGE INTENTIONALLY LEFT BLANK

Due to ongoing product improvements, specifications and dimensions are subject to change and correction without notice or incurring obligations. Determining the application and suitability for use of any product is the responsibility of the installer. Additionally, the installer is responsible for verifying dimensional data on the actual product prior to beginning any installation preparations.

Incentive and rebate programs have precise requirements as to product performance and certification. All products meet applicable regulations in effect on date of manufacture; however, certifications are not necessarily granted for the life of a product. Therefore, it is the responsibility of the applicant to determine whether a specific model qualifies for these incentive/rebate programs.

Comfort-Cire[®] **Century**[®]

1900 Wellworth Ave., Jackson, MI 49203 • Ph. 517-787-2100 • www.marsdelivers.com



LC1090

